



CATÁLOGO 2024



Krealia®

Pol. Ind. Boadilla - Nave 9,
C/Cobalto 45200
ILLESCAS - TOLEDO
Apdo. de correos 104
E-mail: info@krealiagestion.com
Teléfono / Fax: 925 51 14 62

www.krealiagestion.com

INDICE

PARQUES INFANTILES

Serie Marina.....	2 - 9
Serie Bichos.....	10 - 17
Serie Safari.....	18 - 25
Serie Elfos.....	26 - 27
Serie Torre Aventura.....	28 - 41
Multijuegos.....	42 - 46
Paneles lúdicos.....	47 - 50
Balancines.....	50 - 61
Carruseles.....	51
Columpios.....	62 - 67
Toboganes.....	68 - 71
Pórticos/Vallas/Puertas.....	72 - 73
Pavimento de seguridad.....	74 - 77



BIOSALUDABLES 76 - 82



CIRCUITO DEPORTIVO 83



CALISTENIA

Aparatos y circuitos.....83 - 87



PISTAS MULTIDEPORTE

Pistas y accesorios.....88 - 91

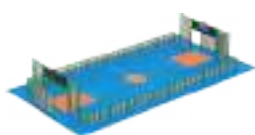

MOBILIARIO URBANO

Bancos.....	92-100
Papeleras.....	101-105
Fuentes.....	106-107
Jardineras.....	108
Pilonas.....	109



AGILITY

Circuitos y accesorios.....110-112





Juegos con visión



Ref. 81423



Ref. 81424



Ref. 81344

Ref. 81343



NOVEDAD



CANGREJO ERMITAÑO Ref. 81343

Edad de uso ≥ 3 años (15 usuarios)

Área de seguridad 5,40x9,65 m

Altura de caída 1,40/1,64 m

Dimensiones 7,20x2,40x3,02 m



7,20



3,02





NOVEDAD



FARO Ref. 81344

Edad de uso ≥ 2 años (15 usuarios)
 Área de seguridad 5,68x10,3 m
 Altura de caída 1,20/1,67 m
 Dimensiones 7,34x3,24x5,26 m



BARCO GOLETA

Ref. 81424



Edad de uso ≥ 3 años (22 usuarios)
Área de seguridad 11,86x6,90 m
Altura de caída 0,88 m
Dimensiones 8,96x4,96x4,88 m
Peso 550 kg



NOVEDAD



8,96 m



OTROS MOTIVOS MARINOS



Páginas 55 y 57



Páginas 54 y 56



Página 60



Página 58

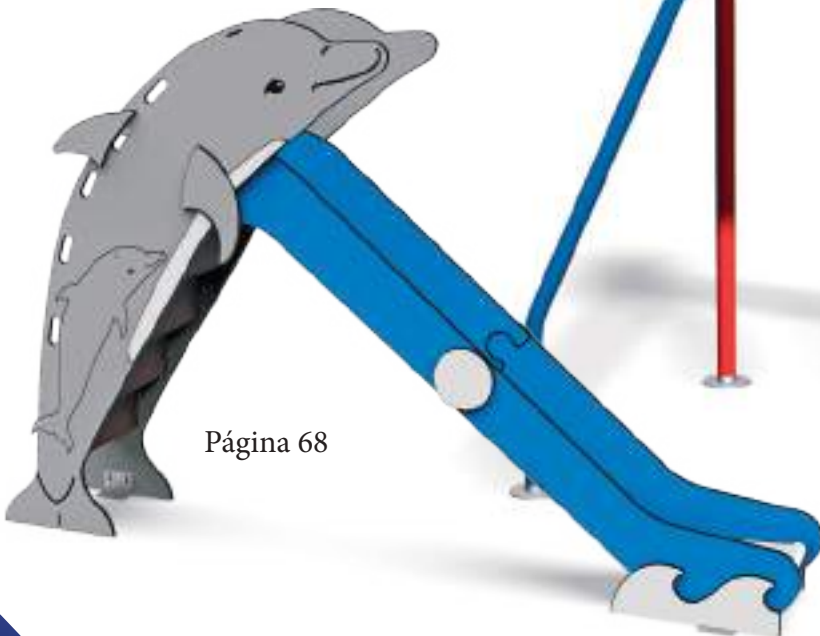

Página 68



Página 66



BARCO MALTA Ref. 81100

Edad de uso ≥ 2 años (10 usuarios)

Área de seguridad 6,87x6,07 m

Altura de caída 0,88/1,77 m

Dimensiones 4,40x3,07x2,43 m

Peso 211 kg

RENOVADO

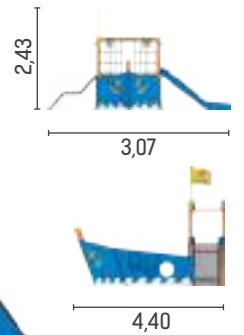



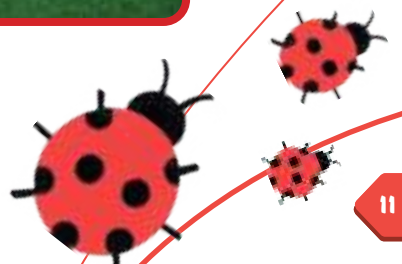



**SERIE BICHOS,
materiales predominantes:**

HPL impresión digital, máxima resistencia UV (EN438-6). Acero galvanizado y pintura de poliéster al horno. Rampa y tornillería de acero inoxidable.

ABEJA Ref. 81222

Edad de uso ≥ 2 años (8 usuarios)
 Área de seguridad 5,74x6,23 m
 Altura de caída 1,23 m
 Dimensiones 2,74x3,76x3,18 m
 Peso 300 kg

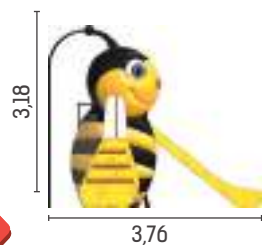

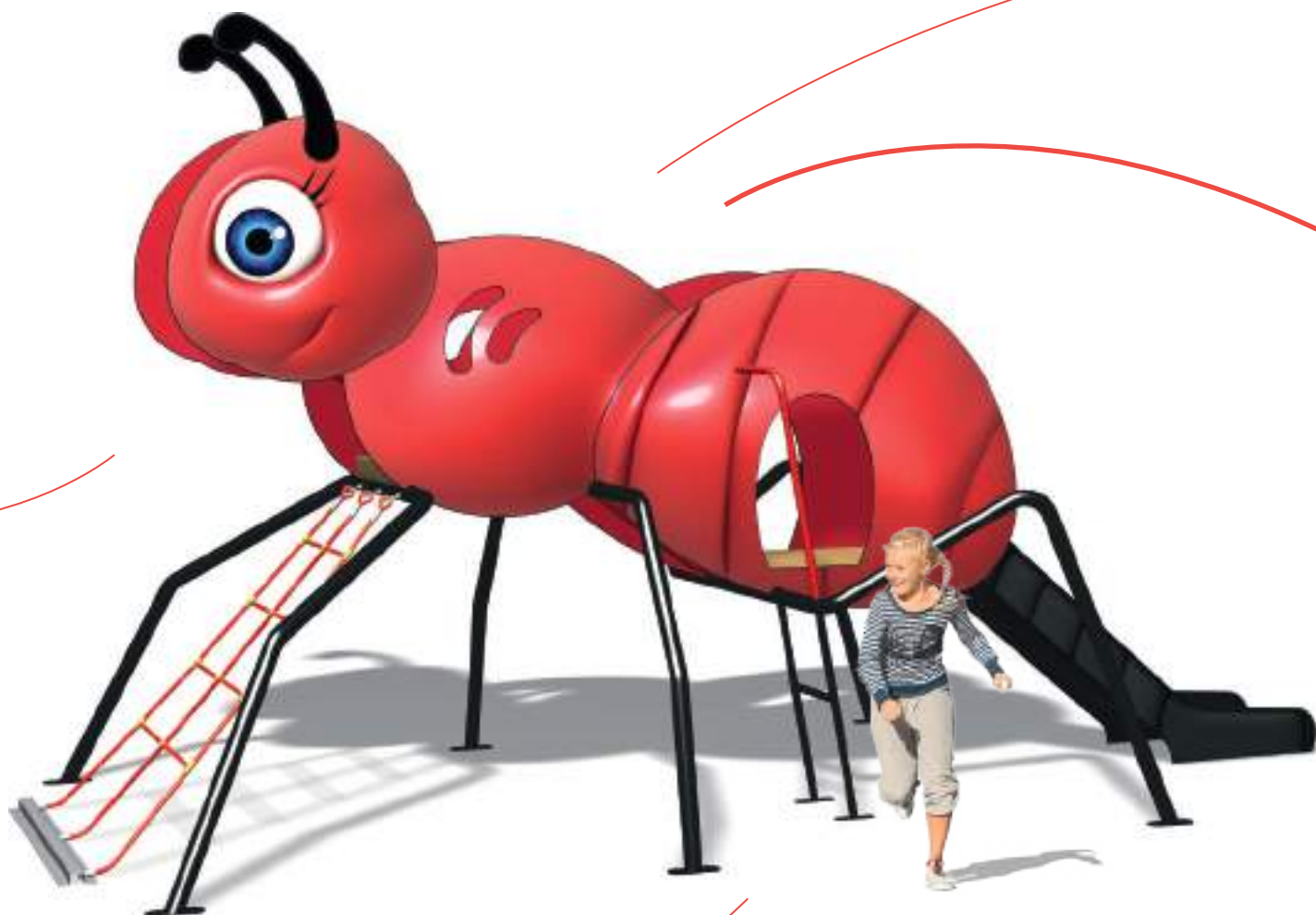

HORMIGA Ref. 81219

Edad de uso \geq 3 años (10 usuarios)

Área de seguridad 7,70x5,39 m

Altura de caída 1,30 m

Dimensiones 5,08x2,40x2,86 m

Peso 240 kg

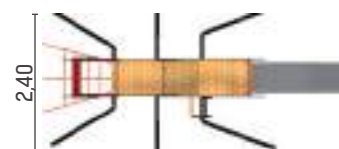
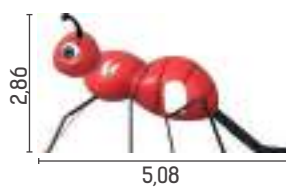

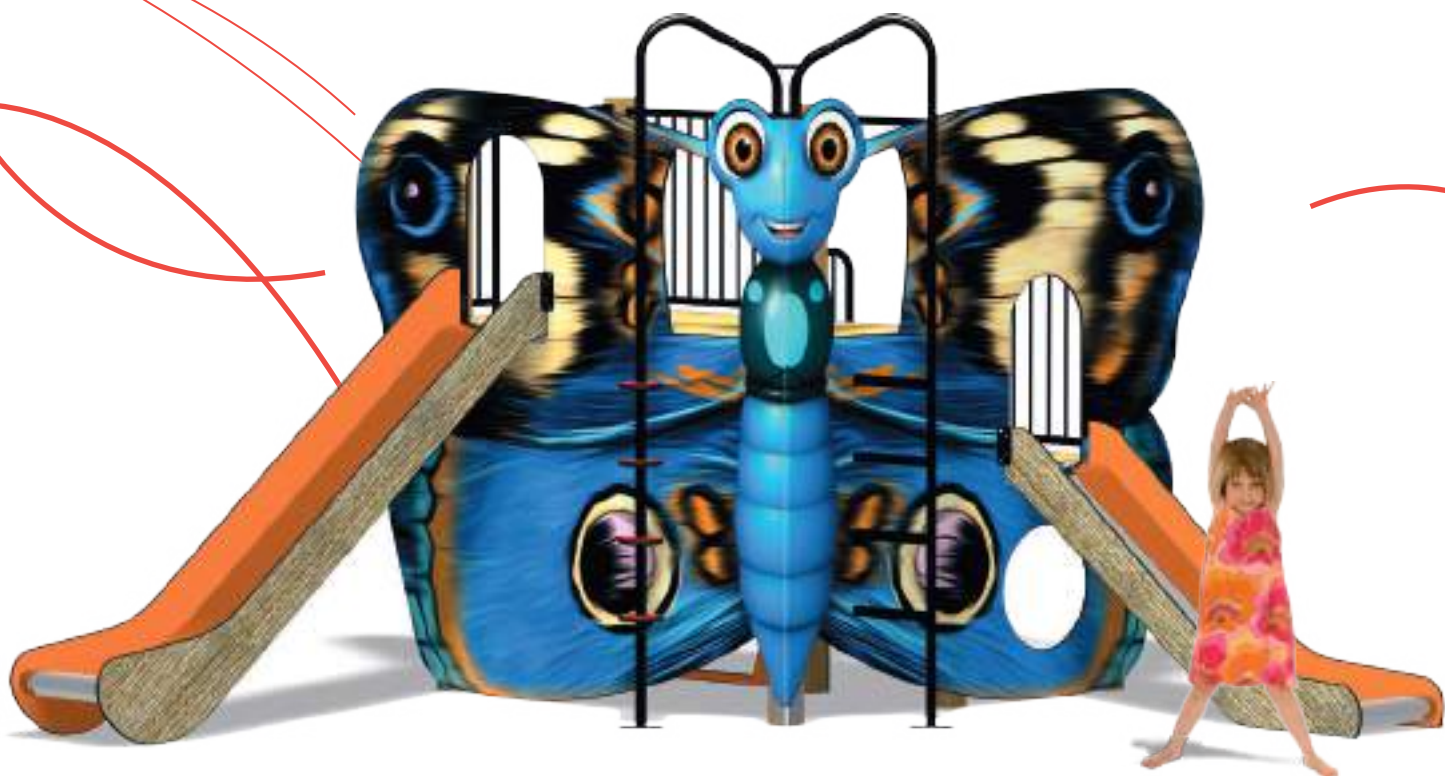

MARIPOSA Ref. 81220

Edad de uso ≥ 2 años (10 usuarios)
 Área de seguridad 6,53x6 m
 Altura de caída 1,40 m
 Dimensiones 4,51x4x2,57 m
 Peso 430 kg

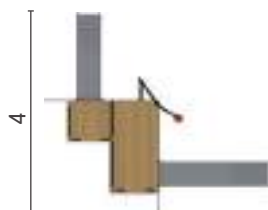
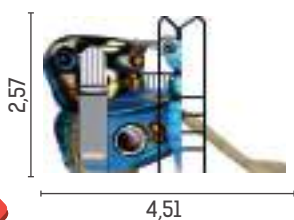

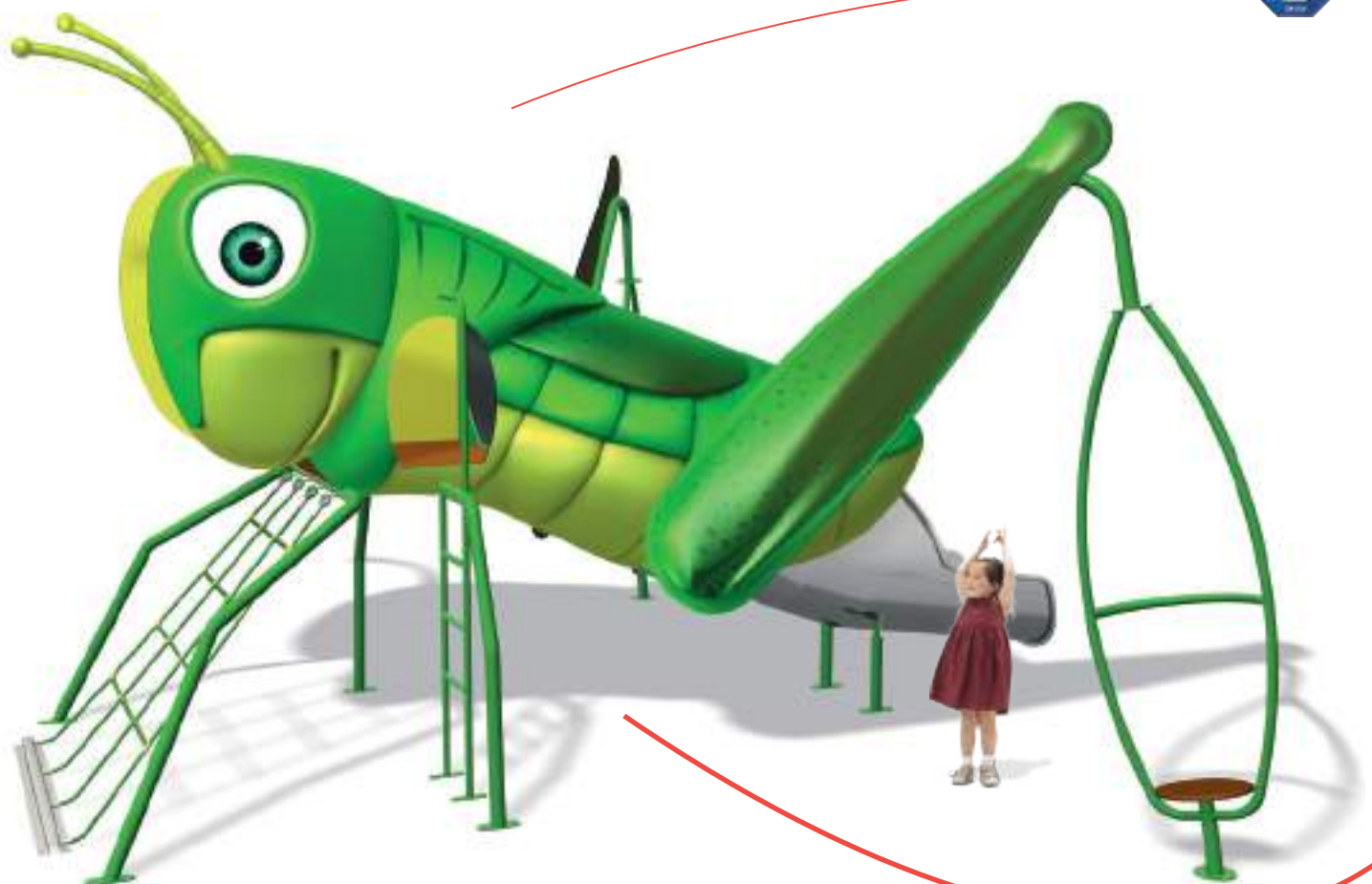

SALTAMONTES

Ref. 81259 Túnel en acero inoxidable.
 Ref. 81224 Túnel acero galv. pintura al horno.

Edad de uso \geq 3 años (12 usuarios)
 Área de seguridad 8,65x8,71 m
 Altura de caída 1,41 m
 Dimensiones 5,16x5,86x3,36 m
 Peso 400 kg

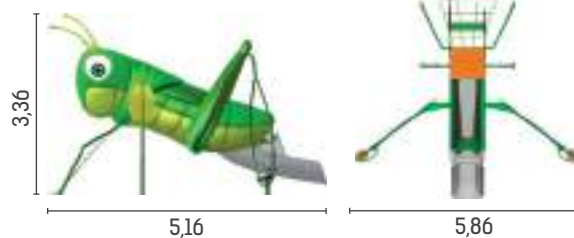



ARAÑA Ref. 81223

Edad de uso ≥ 3 años (12 usuarios)
 Área de seguridad 7,52x8,66 m
 Altura de caída 1,41/1,94 m
 Dimensiones 4,39x5,75x2,17 m
 Peso 200 kg

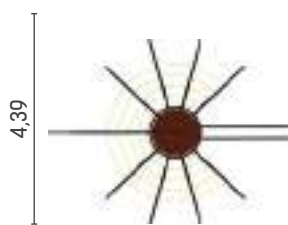
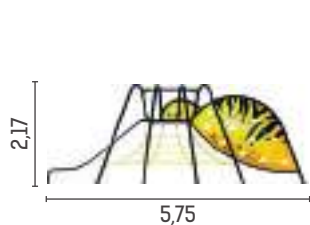
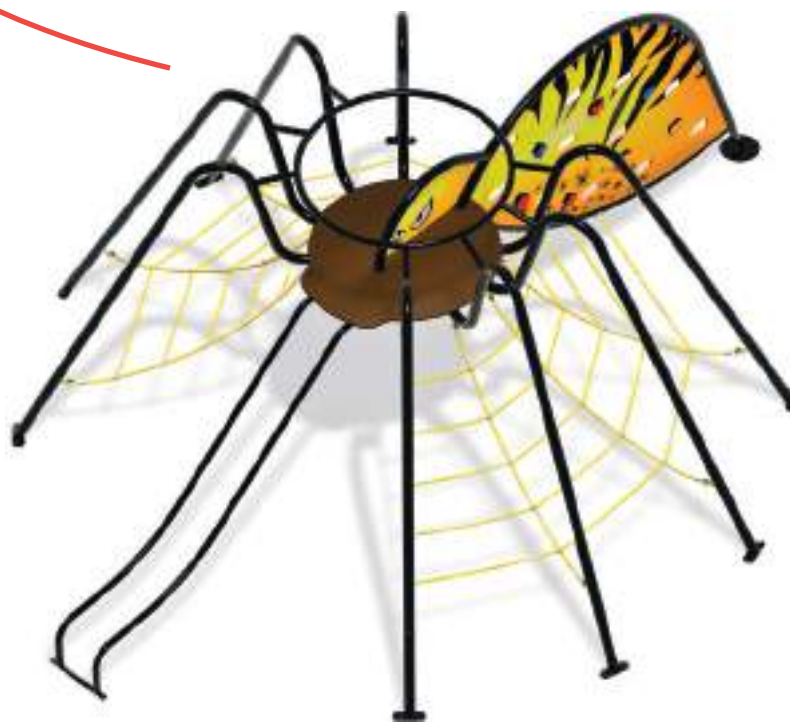



RENOVADO

MARIQUITA-22 REF. 81622

Edad de uso ≥ 2 años (10 usuarios)

Área de seguridad 7,31x5,66 m

Altura de caída 1,63 m

Dimensiones 3,09x4,14x3,56 m

Peso 580 kg

MARIQUITA REF. 81221

(modelo sin tobogán
ni barra para trepar)





CONGO Ref. 81202

Edad de uso ≥ 2 años (4 usuarios)

Área de seguridad 5,08x4,33 m

Altura de caída 0,64 m

Dimensiones 2,70x2,02x2,46 m

Peso 150 kg

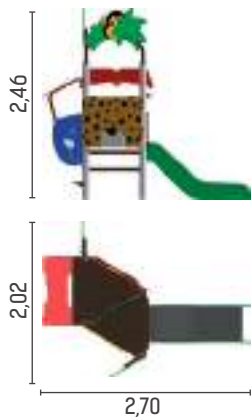

**SERIE SAFARI,
materiales
predominantes:**

Paneles polietileno alta densidad (HDPE), plataformas de panel fenólico, postes de aluminio anodizado y metal galvanizado pintado al horno. Rampa y tornillería de acero inoxidable, lo que garantiza una gran resistencia y durabilidad.



ANGOLA Ref. 81205

Edad de uso ≥ 3 años (6 usuarios)

Área de seguridad 5,08x4,92 m

Altura de caída 0,95 m

Dimensiones 2,70x2,23x3,01 m

Peso 205 kg

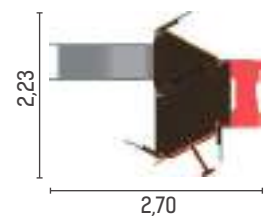
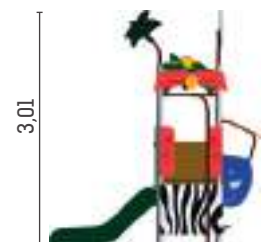



TANZANIA Ref.81206

Edad de uso ≥ 3 años (4 usuarios)
 Área de seguridad 5,26x4 m
 Altura de caída 1,22 m
 Dimensiones 2,83x1,59x3,01 m
 Peso 115 kg

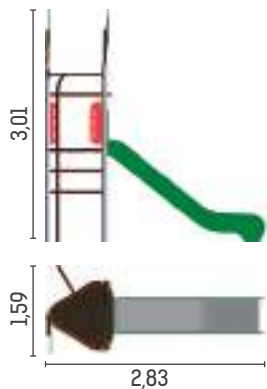



KENIA Ref. 81207

Edad de uso ≥ 3 años (10 usuarios)

Área de seguridad 5,58x6,99 m

Altura de caída 1,94/1,22 m

Dimensiones 4,07x3,16x3,01 m

Peso 250 kg

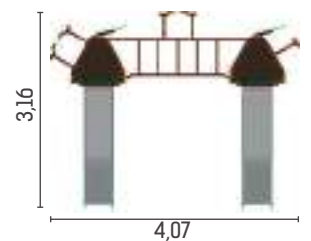
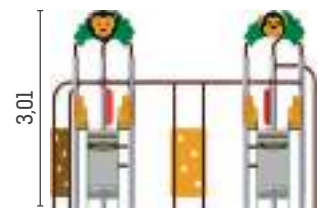



RENOVADO

GUINEA Ref. 81209

Edad de uso todas las edades
 (12 usuarios)
 Área de seguridad 6,61x6,68
 Altura de caída 0,68
 Dimensiones 3,69x3,81x3,01 m

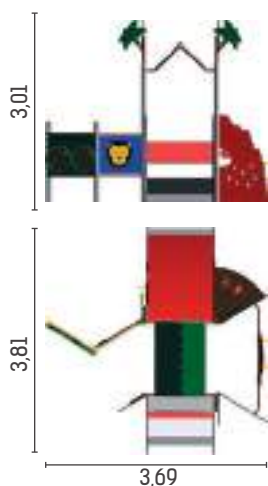

NOVEDAD

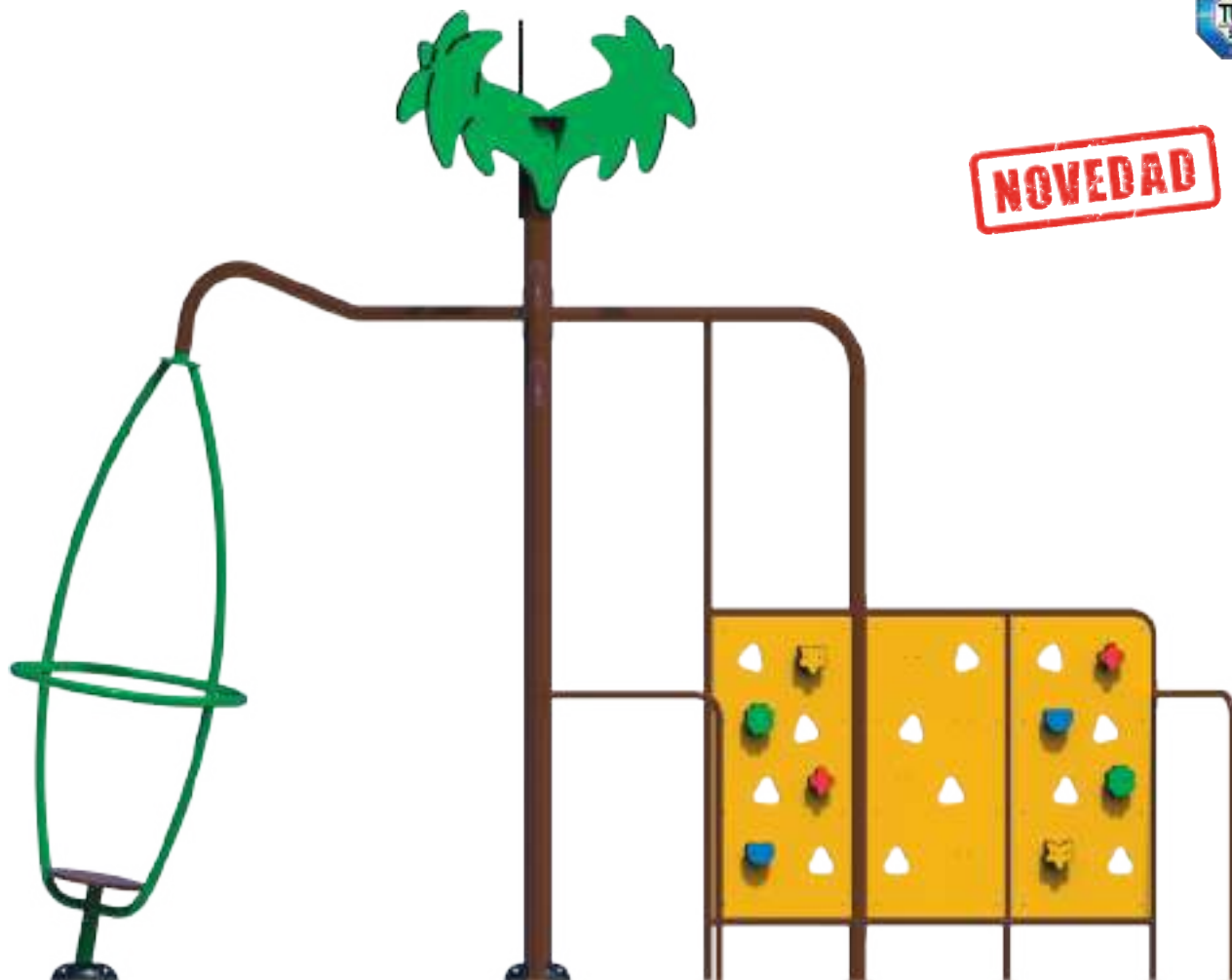

GIRO PALMERA CON TREPAS Ref. 81426

Edad de uso \geq 3 años
 Altura de caída 1,36 m
 Zona de caída 6,77x6,94 m
 Dimensiones 4,27x3,38x3,38 m

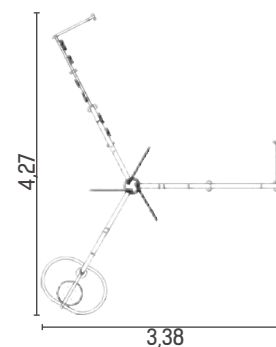
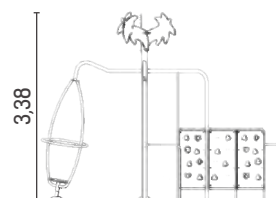

SENEGAL Ref. 81208

Edad de uso ≥ 3 años (14 usuarios)
Área de seguridad 8,33x6,15 m
Altura de caída 1,94 / 1,22 / 0,15 m
Dimensiones 5,89x3,74x3,31 cm

RENOVADO

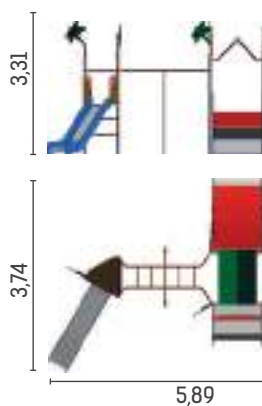



COLONIA ELFOS

Ref. 81365

Edad de uso \geq 1 año (20 usuarios)
 Área de seguridad 9,10x6,40 m
 Altura de caída 0,92 m
 Dimensiones 6,08x4,46x2,42 m

RENOVADO

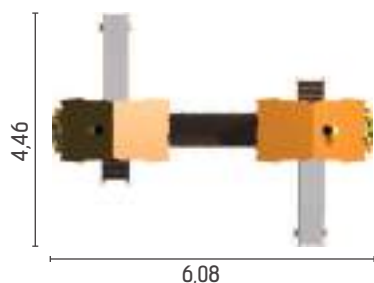

**SERIE ELFOS,
 materiales predominantes:**

Placas de HDPE de colores.
 Tablero fenólico.
 Chapa acero inoxidable y tubo y chapa galvanizados.

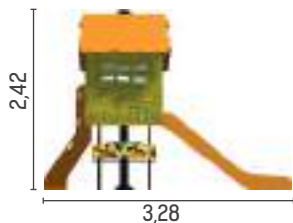

CABAÑA ELFOS

Ref. 81364

Edad de uso \geq 1 año
 Altura de caída 0,92 cm
 Dimensiones 3,28x2,31x2,42 m





CASITA ELFOS

Ref. 81363

Edad de uso \geq 1 año
 Altura de caída \leq 0,60 m
 Dimensiones 2,07x1,23x1,51 m

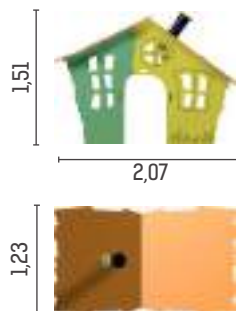

CASITA DUENDE

Ref. 80179

Edad de uso \geq 1 año
 Altura de caída \leq 0,60 m
 Dimensiones 1,88x1,30x1,45 m
 Peso 108 kg





CAPRI Ref. 81158

Edad de uso ≥ 2 años (8 usuarios)
 Área de seguridad 5,54x6,32 m
 Altura de caída 1,08 m
 Dimensiones 2,56x3,87x3,56 m
 Peso 161 kg

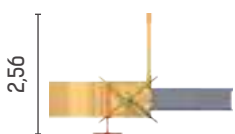
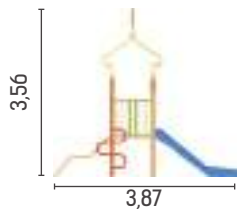



TABARCA Ref. 81159

Edad de uso ≥ 2 años (7 usuarios)
 Área de seguridad 5,69x7,04 m
 Altura de caída 1,10 m
 Dimensiones 4,15x3,87x3,56 m
 Peso 208 kg

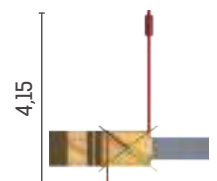
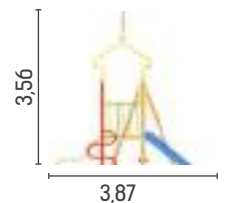



IBIZA Ref. 81108

Edad de uso ≥ 3 años (8 usuarios)
 Área de seguridad 6,14x7,13 m
 Altura de caída 1 m
 Dimensiones 4,13x3,67x2,65 m
 Peso 370 kg

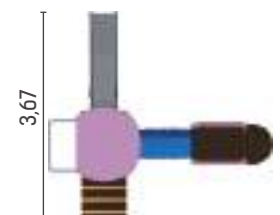
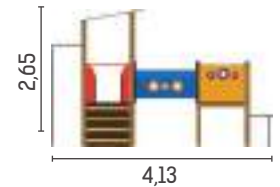

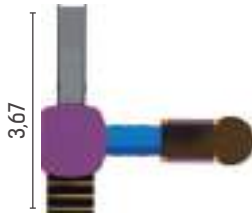
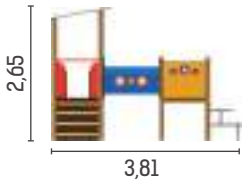

MENORCA Ref. 81109

Edad de uso ≥ 2 años (8 usuarios)

Área de seguridad 6,14x6,81 m

Altura de caída 0,88 m

Dimensiones 3,81x3,67x2,65 m

Peso 370 kg





EGIPTO

Ref.81106

Edad de uso ≥ 3 años
 (6 usuarios)
 Zona de caída
 7,14x4,77 m
 Altura de caída
 1,40 / 1,70 m
 Dimensiones
 4,64x1,64x3,67m
 Peso 225 kg.

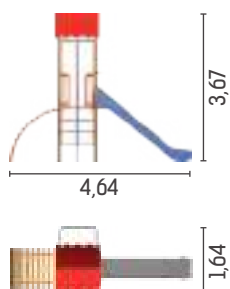

FORMENTERA

Ref. 81107

Edad de uso ≥ 3 años
 (5 usuarios)
 Zona de caída
 6x4,77 m
 Altura de caída
 1,40 / 1,70 m
 Dimensiones
 3,50x1,64x3,67 m
 Peso 195 kg

RENOVADO

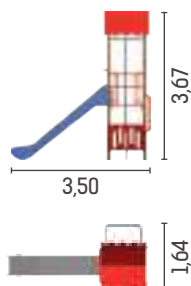



RENOVADO



TEIDE

Ref.81110

Edad uso ≥ 2 años
(7 usuarios)

Zona de seguridad
6,61x6 m

Altura de caída
1,53 / 1,70 m

Dimensiones
3,50x3,43x3,67 m

Peso 220 kg.

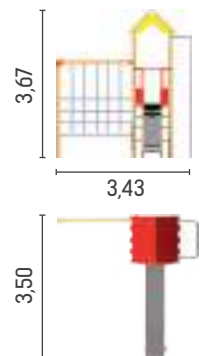



AZORES Ref. 81111

Edad de uso ≥ 3 años (6 usuarios)

Zona de caída 7,85x6,89 m

Altura de caída 1,40 / 1,70 m

Dimensiones 5,45x3,97x3,67 m

Peso 285 kg

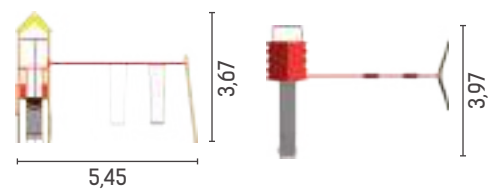



RENOVADO

CORCEGA Ref. 81269

Edad de uso ≥ 2 años (14 usuarios)
 Área de seguridad 8,01x7,52 m
 Altura de caída 1,53 / 1,70 m
 Dimensiones 4,52x3,67x5,51
 Peso 390 kg

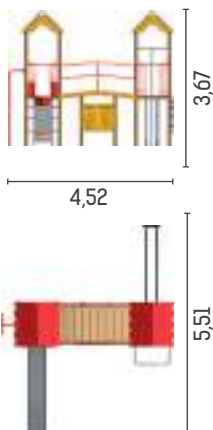



RENOVADO

AMAZONAS Ref. 81104

Edad de uso ≥ 3 años (15 usuarios)
 Zona de caída 8,73x8,85 m
 Altura de caída 1,53 / 1,70 m
 Dimensiones 7,8x3,67x4,52 cm
 Peso 450 kg

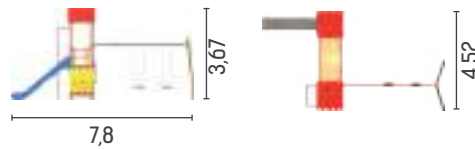

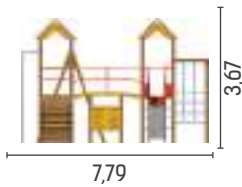

RENOVADO

DOÑANA Ref. 81105

Edad de uso \geq 3 años (14 usuarios)
 Área de seguridad 9,50x8,71 m
 Altura de caída 1,53/1,70 m
 Dimensiones 7,79x3,67x5,54 m
 Peso 520 kg

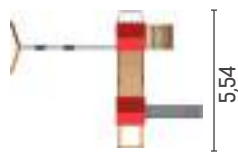

RENOVADO



AVENTURA 3 TORRES Ref. 81113

Edad de uso ≥ 2 años (20 usuarios)
 Área de seguridad 9,90x7,22 m
 Altura de caída 1,47/1,70 m
 Dimensiones 4,18x7,44x3,67 m
 Peso 630 kg

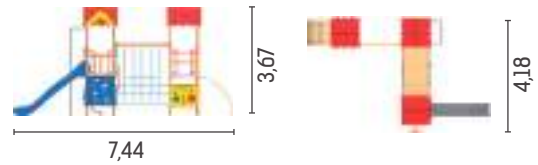

NOVEDAD

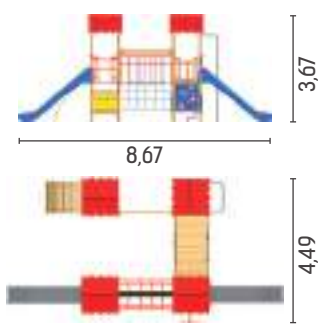

AVENTURA 4 TORRES Ref. 81474

Edad de uso ≥ 3 años (28 usuarios)
 Área de seguridad 10,59x7,52 m
 Altura de caída 1,47/1,70 m
 Dimensiones 8,67x3,67x4,49 m
 Peso 730 kg





AVENTURA 6 TORRES Ref. 81112

Edad de uso ≥ 2 años (40 usuarios)
Área de seguridad 13,30x12,60 m
Altura de caída 1,53 / 1,70 m
Dimensiones 11,69x9,51x3,65 m
Peso 1.500 kg



RENOVADO



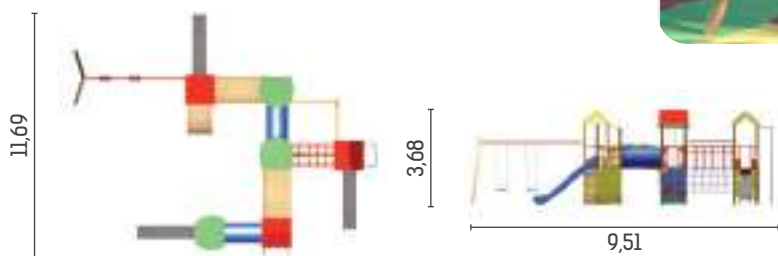

TREN COMBIEXPRESS Ref. 81170

Edad de uso ≥ 1 años (13 usuarios)
 Altura de caída $\leq 0,60$ m



VAGÓN CUBIERTO
 Ref. 81102
 1,56x1,09x1,67 m
 Peso 107 kg

VAGÓN DESCUBIERTO
 Ref. 81103
 1,56x1,04x0,90 m
 Peso 87 kg

LOCOMOTORA
 Ref. 81101
 2,63x1,14x1,84 m Peso 191 kg



TUNEL HDPE MOD. AVISPA Ref. 81631

Edad de uso ≥ 1 años (3 usuarios)
 Medidas 1,40x1,14x0,85 m
 Peso 40 kg





LE AYUDAMOS A REALIZAR SU MEJOR PROYECTO

KREALIA GESTIÓN, pone a su servicio su oficina técnica, formada por personal cualificado para realizar el diseño más adecuado de su parque infantil, sin compromiso alguno por su parte, cumpliendo con la norma EN1176.



Proyectos Especiales



PROYECTOS REALIZADOS

TIROLINA AMAZONIA Ref.81377

Edad de uso ≥ 6 años
 Altura de caída 1,80 m
 Medidas: 29,07x4,52x4,24 m
 Longitud 25 m



TREPA 4 Ref.80715

Edad de uso ≥ 3 años
 Zona de caída 6,78x5,49 m
 Altura de caída 2,48 m
 Dimensiones 2,42x1,12x2,48 m
 Peso 128 kg



TREPA 5 Ref.80716

Edad de uso ≥ 3 años
 Dimensiones 1,92x1,08x2,42 m
 Zona de caída 4,08x4,92 m
 Altura de caída 1,36 m
 Peso 84 kg



NOVEDAD



(Línea de 25 m)



ARENERO Ref.80219

Dimensiones 3,12x3,12x0,24 m

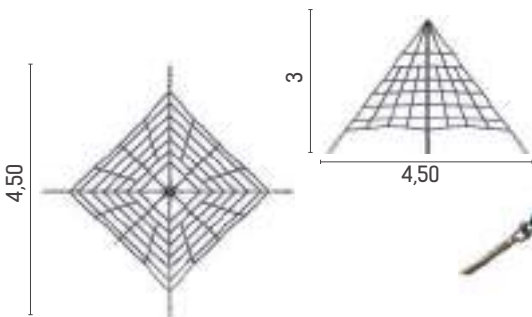

PIRÁMIDE Ref. 80836

Edad de uso ≥ 3 años
 Zona de caída \varnothing 7,50 m
 Altura de caída 1,50 m
 Dimensiones 4,50x4,50x3 m
 Peso 70 kg





MESA MULTIJUEGO BASKET

Ref. 81440

Edad de uso ≥ 2 años.
 Área de seguridad 1,5 m perimetral
 Dimensiones 2,80x1,48x0,90 m
 Peso 130 kg
 Tablero de HDPE y patas de tubo galvanizado

NOVEDAD

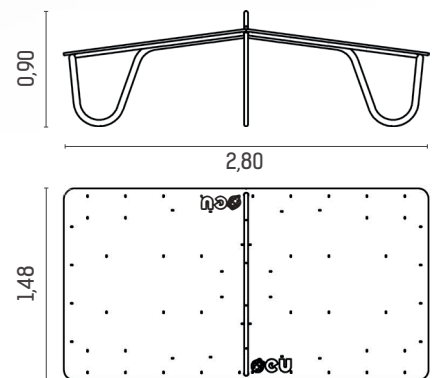

MESA MULTIJUEGO FÚTBOL Ref. 81441

Edad de uso ≥ 2 años.
 Área de seguridad 1,5 m perimetral
 Dimensiones 2,80x1,48x0,90 m
 Peso 130 kg
 Tablero de HDPE y patas de tubo galvanizado



MESA DE JUEGOS ESTÁNDAR

PARCHÍS



Ref. 80220

Ref. 81225

AJEDREZ

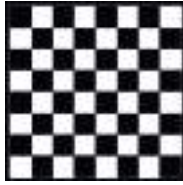

Ref. 80221

Ref. 81226

OCA



Ref. 80223

Ref. 81227



MESA INCLUSIVA

HPL de máxima resistencia UV (EN438-6)

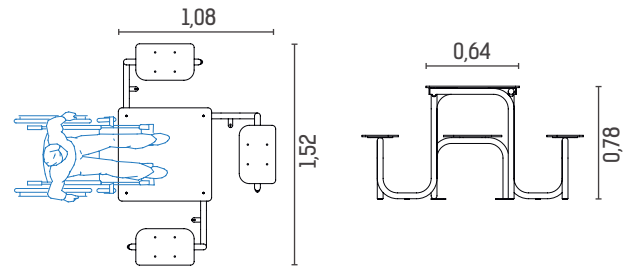

TWISTER Ref. 81431

Edad de uso ≥ 2 años.

Área de seguridad 1,5 m perimetral
Panel de HDPE. Postes de madera y anclaje de chapa galvanizada.

NOVEDAD

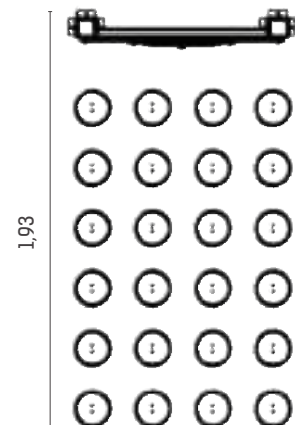
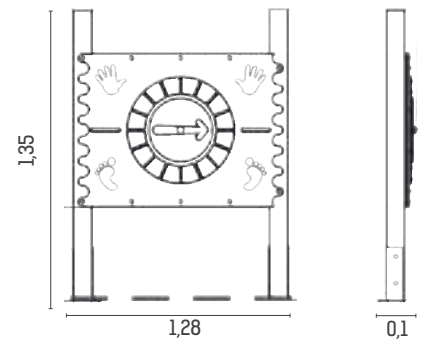

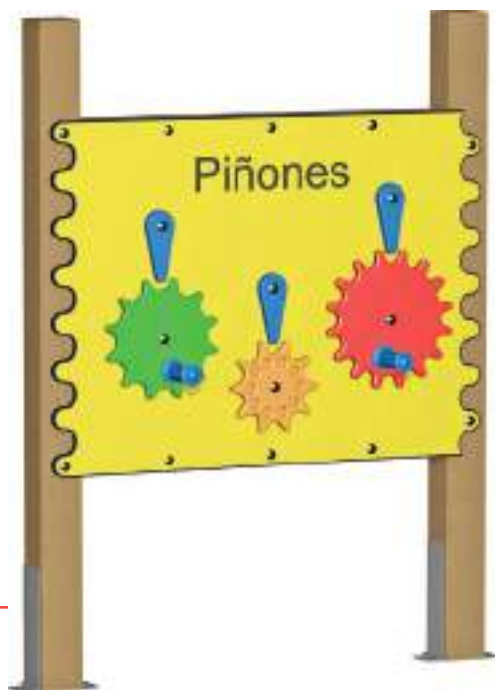

PIÑONES

Ref. 81370

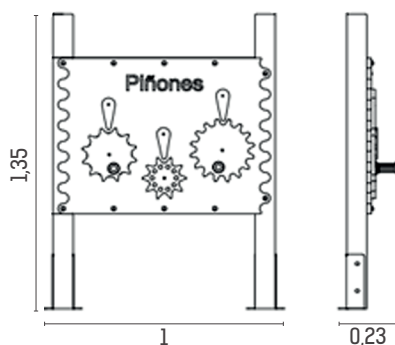

Paneles lúdicos:

Edad de uso ≥ 2 años.
 Área de seguridad 1,5 m perimetral.
 Peso del conjunto 26 kg.
 Panel de HDPE. Postes de madera
 y anclaje de chapa galvanizada.

NOVEDAD

CAR RACING

Ref. 81396

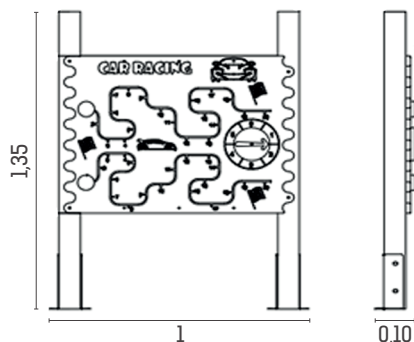

CIRCUITO CARRERAS

Ref. 81397 azul/rojo

NOVEDAD

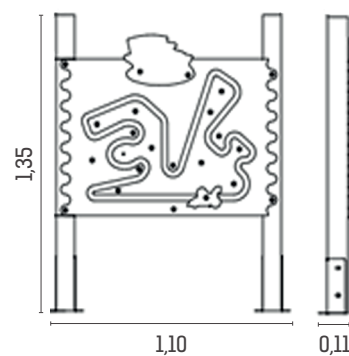



LABERINTO

Ref. 81366

NOVEDAD

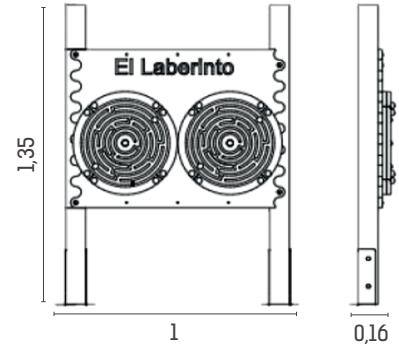

GNOMOS Y RELOJ

Ref. 81369

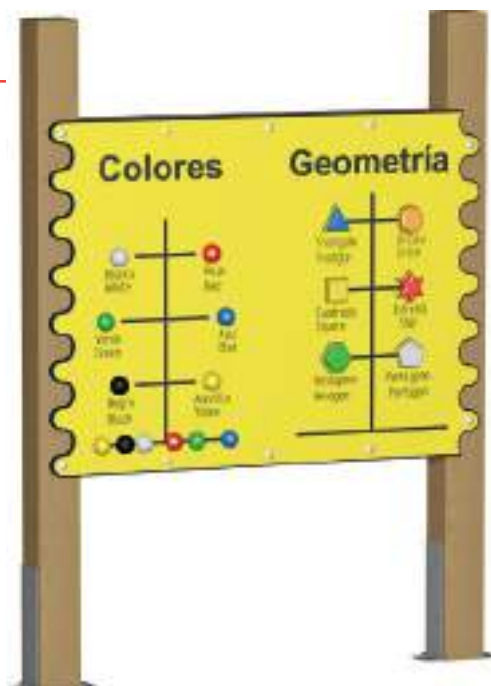
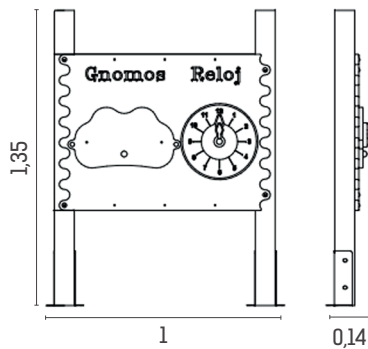

GEOMETRÍA Y COLORES

Ref. 81368

NOVEDAD

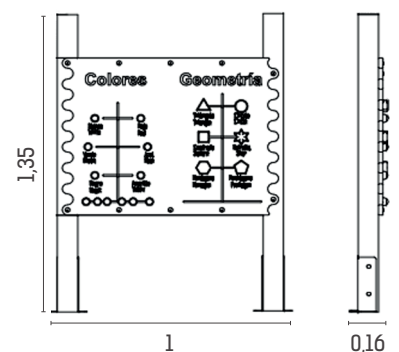

BALANCINES

BALANCÍN PARCHÍS Ref.81132



Edad de uso ≥ 2 años
Área de seguridad $\varnothing 3$ m
Altura de caída 0,45 m
Dimensiones $\varnothing 1 \times 0,56$ m
Peso 27,5 kg.

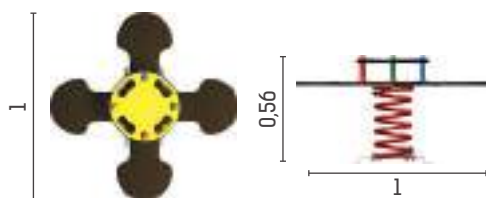

BALANCÍN DÚO Ref.81258

Edad de uso ≥ 1 año
Área de seguridad $\varnothing 3$ m
Altura de caída 0,45 m
Dimensiones $\varnothing 1 \times 0,50 \times 0,56$ m
Peso 26 kg.

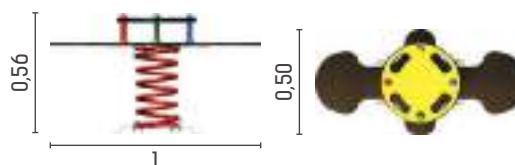



CARRUSEL Ref. 80252



CARRUSEL CON ASIENTOS Ref. 81282

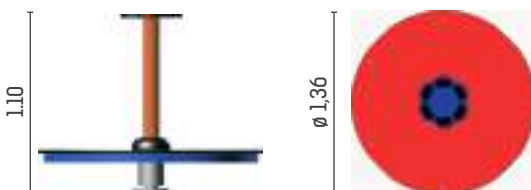

CARRUSEL CON BARANDAS Ref. 81283

Edad de uso \geq 3 años
 Área de seguridad \varnothing 5,36 m
 Altura de caída 0,28 m

Dimensiones \varnothing 1,36 x 1,10 m
 Peso 105 kg
 Peso 80252/105 Kg - 81282/140 Kg - 81283/125 Kg



**SERIE BALANCINES,
una plaza:**

Edad de uso ≥ 2 años.
 Área de seguridad 2,40x3 m
 Altura de caída 0,53 m
 Dimensiones variables
 Peso del conjunto 24 kg.
 Paneles de **Polietileno de alta densidad (HDPE)**

JIRAFÁ Ref.81123

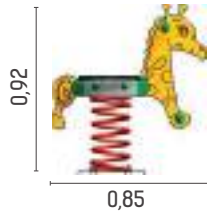

BERNARD Ref.81130

**ANCLAJE ARENERO
BALANCÍN Y TOBOGÁN**
Ref. 81615

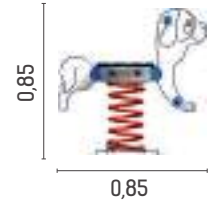

MARATÓN Ref.80614

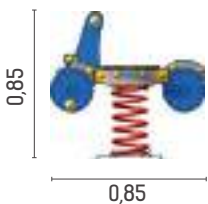



PEGASO Ref.81133

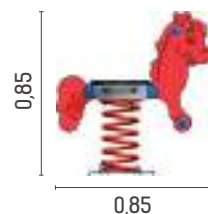

LIEBRE Ref.81131

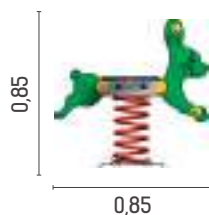

HIPOPÓTAMO Ref.81122

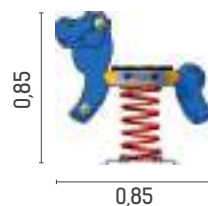

BALANCINES

MARIQUITA Ref.80746/80747 (1/2 plazas)

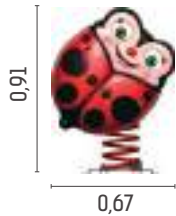

OSO Ref.80628/80635 (1/2 plazas)

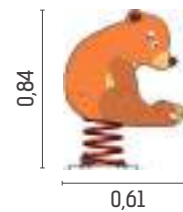

FOCA Ref.80748/80749 (1/2 plazas)

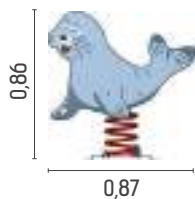

SERIE BALANCINES 1/2 PLAZAS

Edad de uso ≥ 2 años.
Área de seguridad 2,43x3,02 m.
Altura de caída 0,45 m.

Dimensiones variables
Peso del conjunto 30 kg.
Paneles de PHPL máxima resistencia UV (EN438-6)



ABEJA Ref.80742/80743
(1/2 plazas)

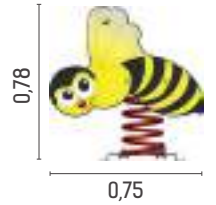

BALLENA Ref.80744/80745
(1/2 plazas)

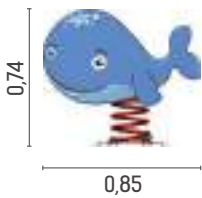

PATO Ref.80627/80634
(1/2 plazas)

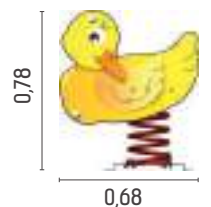

FOCA ADAPTADO Ref. 81375



NOVEDAD

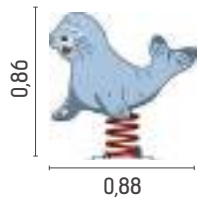

Gama de balancines adaptados con respaldo de 1 plaza.
 Edad de uso **2-8 años**.
 Dimensiones **variables**.
 Altura de caída **0,45 m**.
 Paneles de HPL máxima resistencia UV (EN438-6).
 Peso **30 kg** aprox.

OSO ADAPTADO Ref. 81373

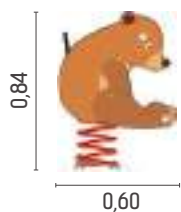



BALLENA ADAPTADO Ref. 81371

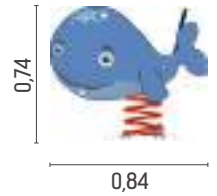

PATO ADAPTADO Ref. 81374

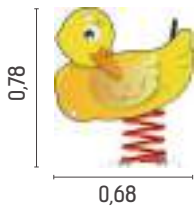

**ANCLAJE ARENERO
BALANCÍN Y TOBOGÁN
Ref. 81615**



MARIQUITA ADAPTADO Ref. 81372

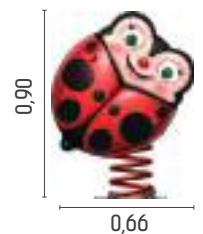

SUBE Y BAJA CABALLITO DE MAR Ref.81255

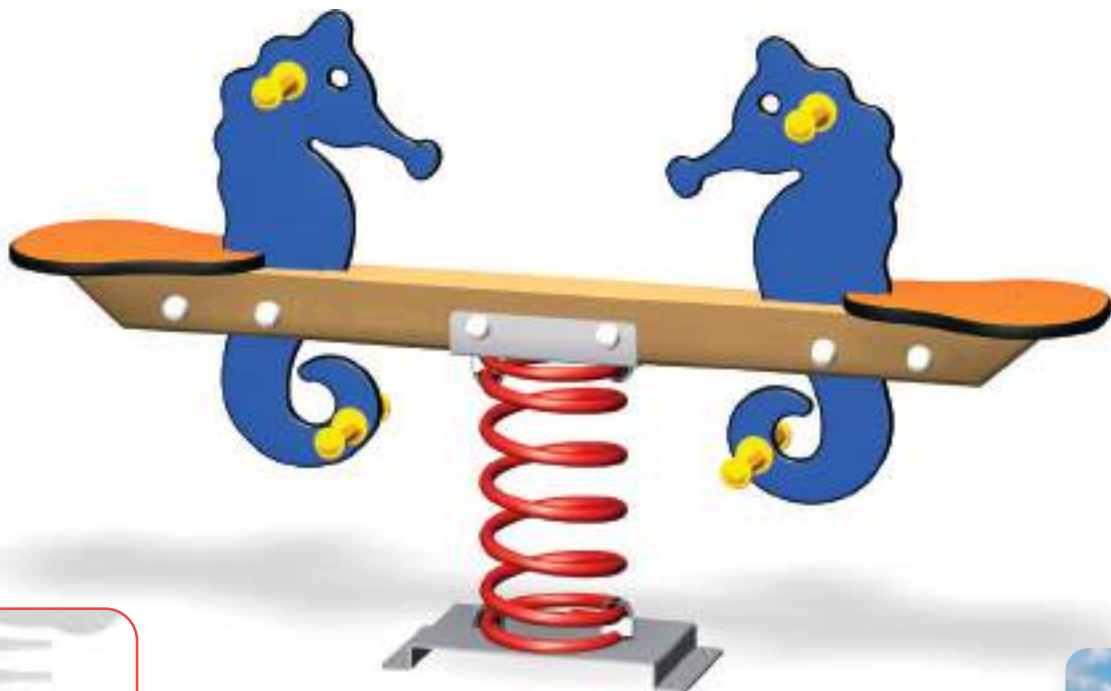

ANCLAJE ARENERO BALANCÍN Y TOBOGÁN
Ref. 81615



SUBE Y BAJA UNICORNIO Ref.81256

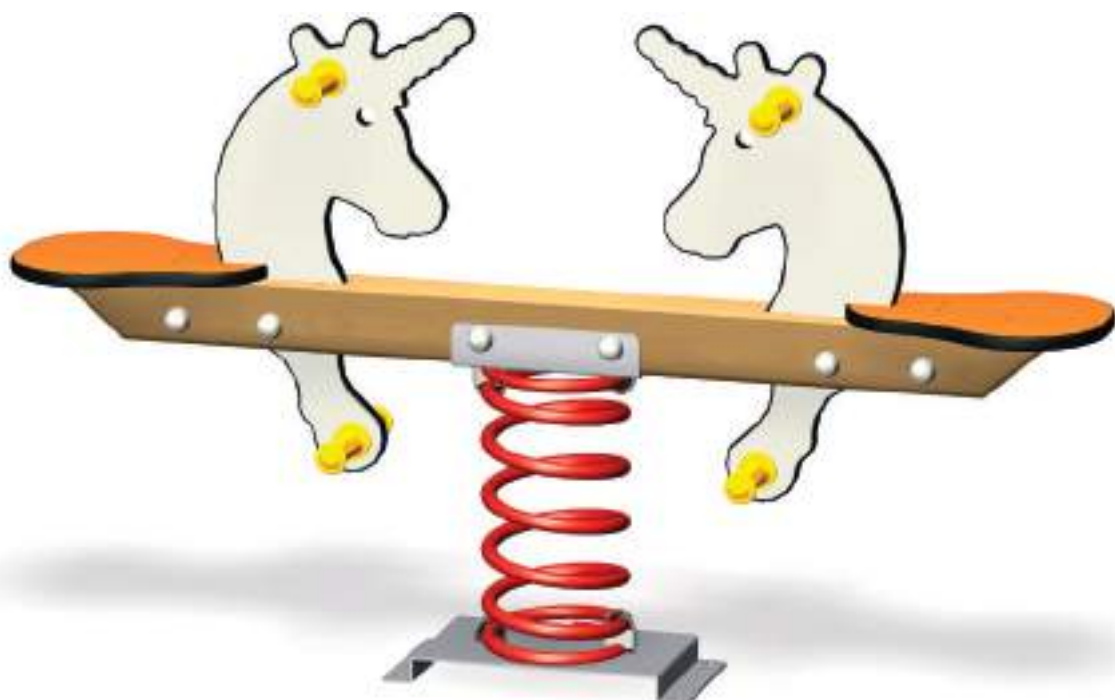

Sube y baja de un muelle para dos plazas fabricado en HDPE, acero galvanizado y maderas tratadas.



SUBE Y BAJA RINOCERONTE Ref.81264

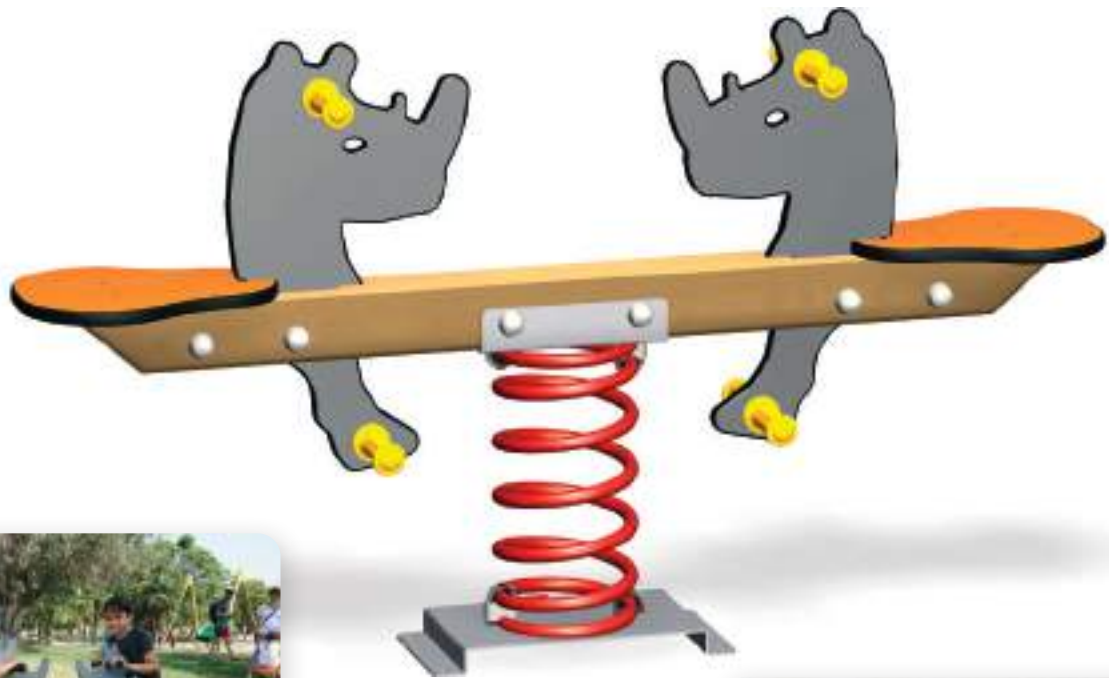

SUBE Y BAJA JIRAFAS Ref.81257

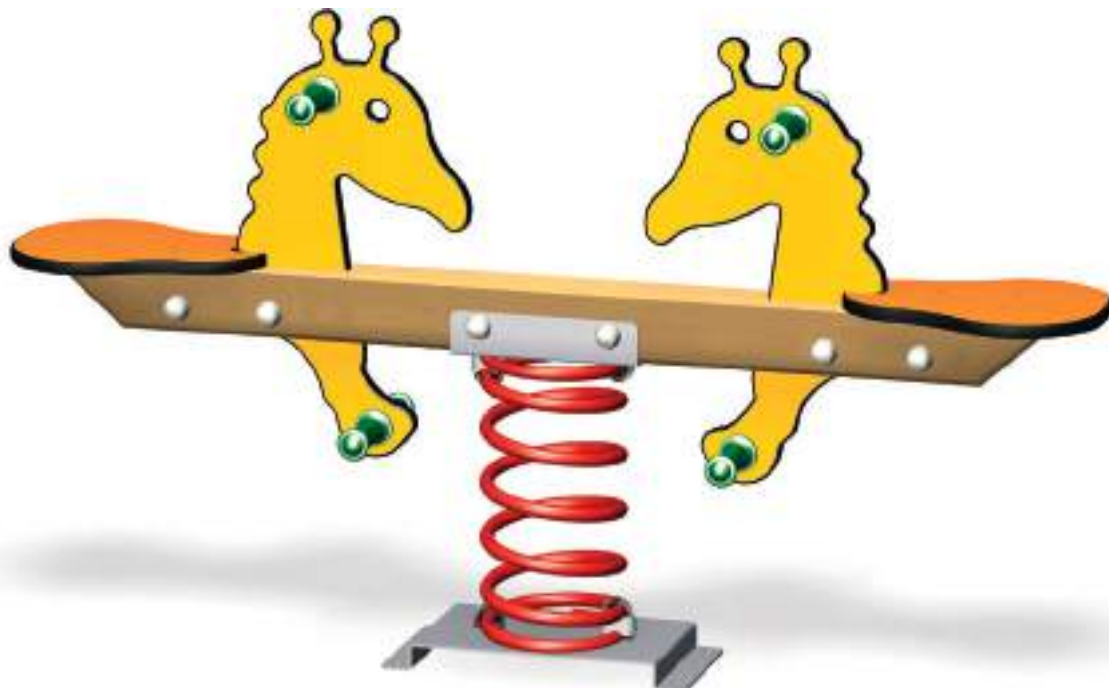

SUBE Y BAJA DOS PLAZAS

Edad de uso ≥ 2 años.
 Área de seguridad 2,27x3,51 m.
 Altura de caída 0,54 m.

Dimensiones 1,51x0,26x0,85 a 0,89 m aprox.
 Peso del conjunto 31 kg.
 Paneles de Polietileno alta densidad (HDPE)

SUBE Y BAJA INTEGRADA Ref.81376



Edad de uso ≥ 3 años.
 Área de seguridad 4x2,40 m
 Altura de caída 4,03 m
 Dimensiones 2x1,10x0,75 m
 Materiales tubo y chapa galva con imprimación y pintura termocalada

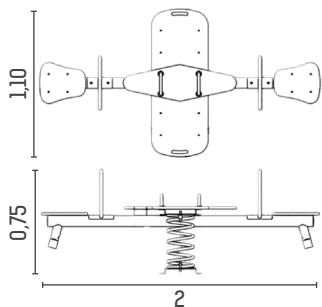

NOVEDAD

SURF Ref.81356

Edad de uso ≥ 3 años
 Zona de caída $\varnothing 3$ m
 Dimensiones 1,20x0,45x0,36 m
 Fabricado con: placa de HDPE, muelle acero pintado con pintura poliéster termolacada, base chapa decapada galvanizada en caliente.

NOVEDAD

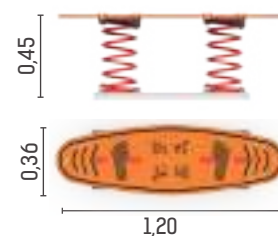
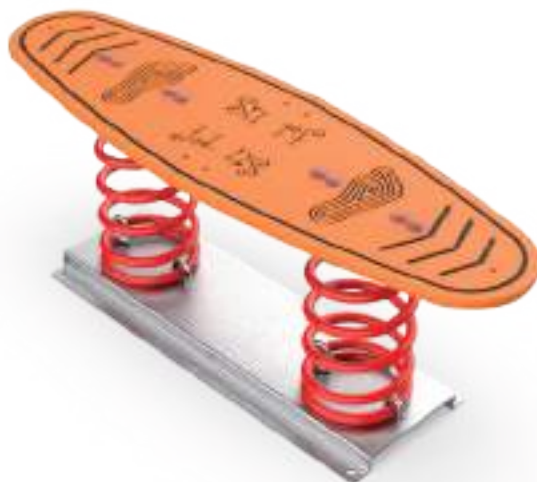

SUBE Y BAJA CABALLITO Ref.81134

Edad de uso ≥ 3 años.
 Área de seguridad 5,04x2,59 m
 Altura de caída $\leq 0,60$ m
 Dimensiones 3,04x0,31x0,89 m
 Peso 81 kg.

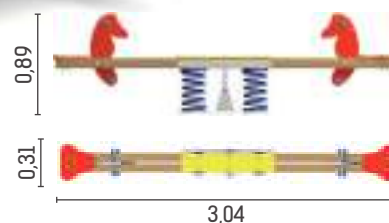



SUBE Y BAJA BRAVO 2M 2 PLAZAS Ref. 80176

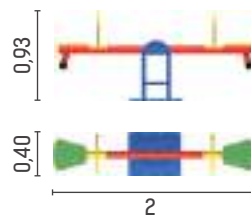

SUBE Y BAJA BRAVO 3M 2 PLAZAS Ref. 80174

4 PLAZAS Ref. 80177

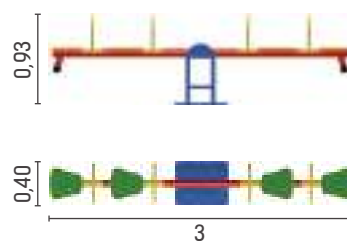

Edad de uso \geq 3 años
Área de seguridad 5x2,40 m (Ref. 80177 y 80174)
4x2,40 m (Ref. 80176)
Altura de caída 0,85 m
Peso 33 Kg / 40 kg / 45 Kg

Dimensiones totales 3x0,93x0,40 m (Ref. 80177 y 80174)
2x0,93x0,40 m (Ref. 80176)
Materiales predominantes: Asientos de HDPE, estructura de acero galvanizado y pintura termolacada, con amortiguación de caucho.



**MECEDOR MINI INDIVIDUAL
ASIENTO PLANO** Ref. 81421
Arenero - Ref. 81445

Edad de uso \geq 2 años
Altura de caída 0,55 m
Dimensiones 1,34x0,24x1,53 m

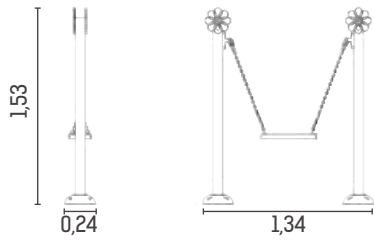

**MECEDOR MINI INDIVIDUAL
ASIENTO CUNA** Ref. 81422
Arenero - Ref. 81446

Edad de uso \geq 2 años
Altura de caída 0,55 m
Dimensiones 1,34x0,31x1,53 m

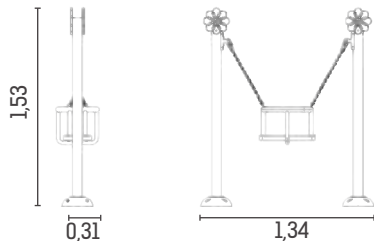

**MECEDOR MINI DÚO ASIENTO
MIXTO** Ref. 81427
Arenero - Ref. 81447

Edad de uso \geq 2 años
Altura de caída 0,55 m
Dimensiones 2,44x0,31x1,53 m



**MECEDOR MINI DÚO ASIENTO
CUNA** Ref. 81444
Arenero - Ref. 81449

**MECEDOR MINI DÚO ASIENTO
PLANO** Ref. 81443
Arenero - Ref. 81448

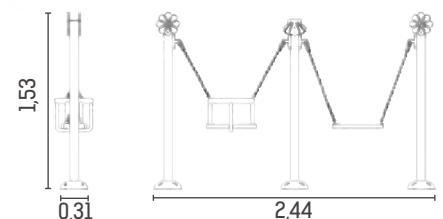

COLUMPIOS

MAXI MIXTO Ref. 80750
MAXI PLANO Ref. 80630
MAXI CUNA Ref. 80632

Edad de uso ≥ 3 años
 (≥ 1 año en asientos cuna)
 Área de seguridad 7,73x3,05 m
 Altura de caída 1,37 m
 Dimensiones 3,67x2,06x2,69 m
 Peso 100 kg

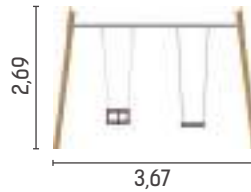

PITIUSA MIXTO Ref. 80751
PITIUSA PLANO Ref. 80647
PITIUSA CUNA Ref. 80646

Edad de uso ≥ 2 años
 (≥ 1 año en asientos cuna)
 Área de seguridad 6,93x2,89 m
 Altura de caída 1,06 m
 Dimensiones 3,07x1,61x1,99 m
 Peso 75 kg

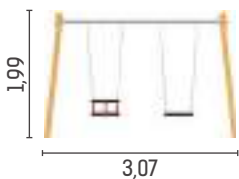



COLUMPIO INDIVIDUAL PLANO Ref. 81241

Edad de uso ≥ 2 años
 Área de seguridad 7,73x1,83 m
 Altura de caída 1,06 m
 Dimensiones 2,50x 1,99x1,58 m

RENOVADO



COLUMPIO INDIVIDUAL CUNA Ref. 81240

Edad de uso ≥ 1 año
 Área de seguridad 7,73x1,83 m
 Altura de caída 1,06 m
 Dimensiones 2,50x1,99x1,58 m

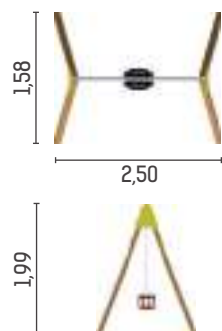

RENOVADO

COLUMPIO ADAPTADO Ref. 81239

Edad de uso ≥ 3 años
 Área de seguridad 7,81x1,83 m
 Altura de caída 1,36 m
 Dimensiones 2,60x2,06x2,69 m

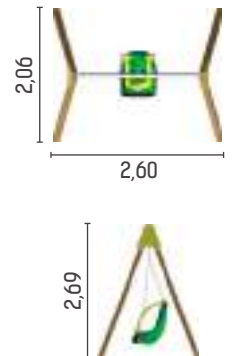

COLUMPIO NIDO Ref. 80128

Edad de uso ≥ 3 años
 Área de seguridad 7,50x2,50 m
 Altura de caída 1,46 m
 Dimensiones 3,67x2,06x2,69 m
 Peso 93 kg

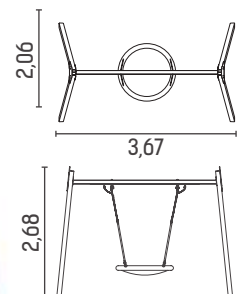



BRAVO JUNIOR INDIVIDUAL PLANO Ref. 81415

Edad de uso ≥ 2 años
 Área de seguridad 6,90x1,83 m
 Altura de caída 1,14 m
 Dimensiones 2,68x2,06x1,37 m

NOVEDAD

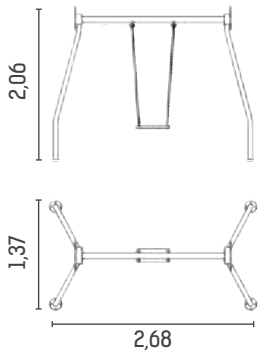

BRAVO JUNIOR INDIVIDUAL CUNA Ref. 81416

Edad de uso ≥ 1 años
 Área de seguridad 6,90x1,83 m
 Altura de caída 1,13 m
 Dimensiones 2,68x2,06x1,37 m

NOVEDAD

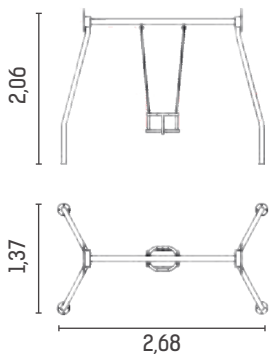

BRAVO MASTER MIXTO Ref. 80185
BRAVO MASTER PLANO Ref. 80183
BRAVO MASTER CUNA Ref. 80184

Edad de uso ≥ 2 años
 (≥ 1 año en asientos cuna)
 Área de seguridad 7,73x3,05 m
 Altura de caída 1,37 m
 Dimensiones 3,39x2,54x2,04 m
 Peso 62 kg



BRAVO JUNIOR MIXTO Ref. 80188
BRAVO JUNIOR PLANO Ref. 80186
BRAVO JUNIOR CUNA Ref. 80187

Edad de uso ≥ 2 años
 (≥ 1 año en asientos cuna)
 Área de seguridad 6,90x3,05 m
 Altura de caída 1,14 m
 Dimensiones 3,03x2,06x1,37 m
 Peso 55 kg





LORO Ref. 80191

Edad de uso ≥ 2 años.
 Área de seguridad 5,94x3,52 m
 Altura de caída 1,40 m
 Dimensiones 3,44x0,52x2,30 m
 Peso 117 kg.

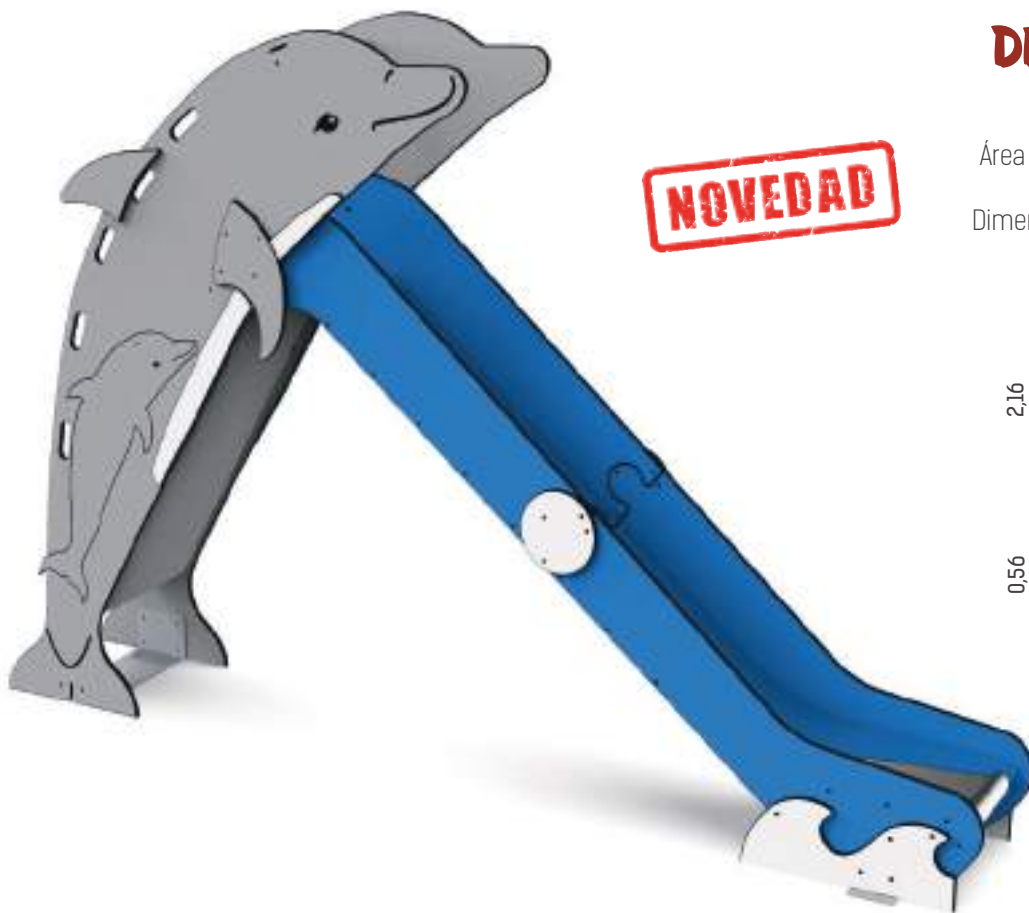
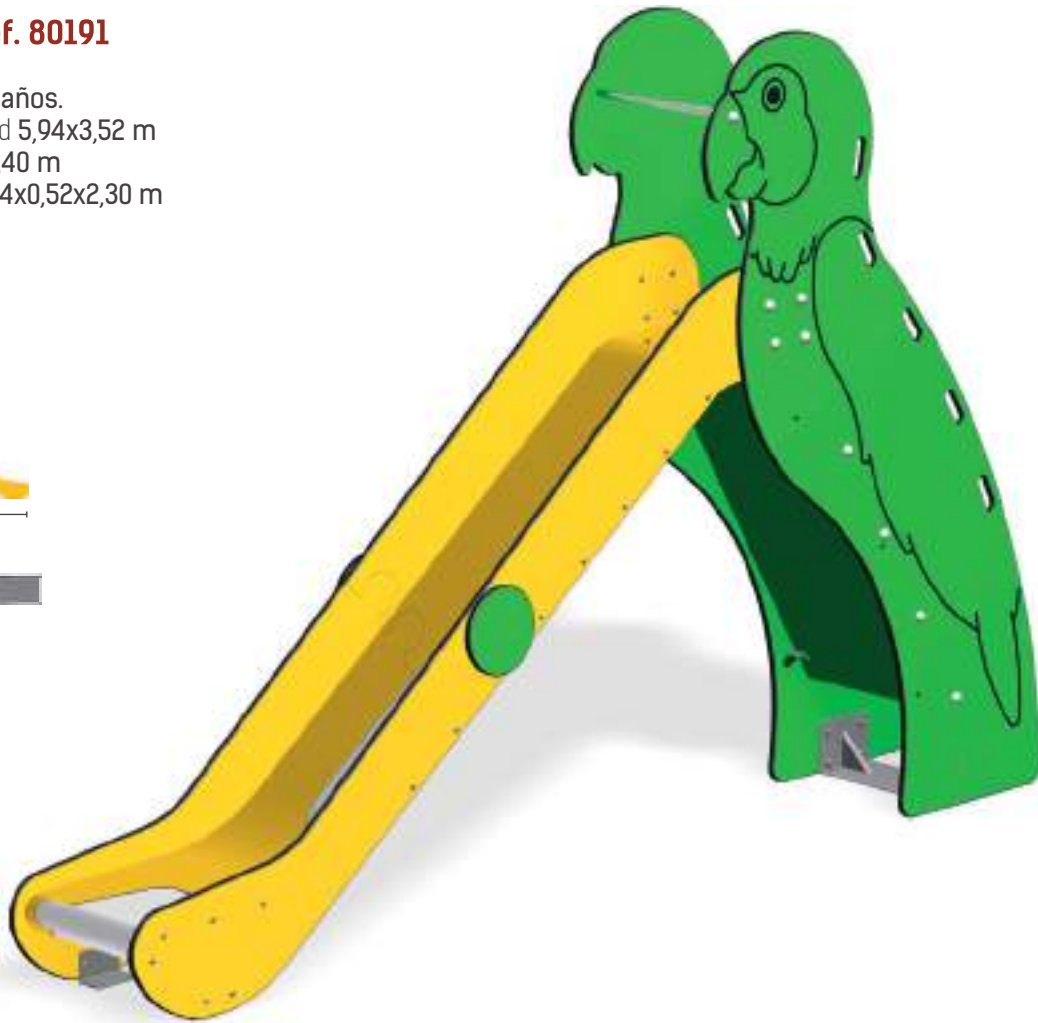
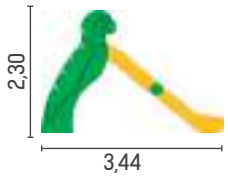

NOVEDAD

DELFIN Ref. 81423

Edad de uso ≥ 2 años
 Área de seguridad 5,81x3,56 m
 Altura de caída 1,4 m
 Dimensiones 3,36x0,56x2,16 m
 Peso 90 kg

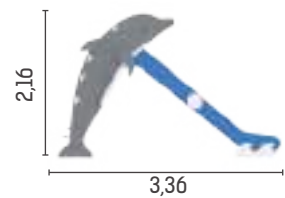



ELEFANTE Ref. 80192

Edad de uso ≥ 2 años.
 Área de seguridad 4,96x3,52 m
 Altura de caída 0,88 m
 Dimensiones 2,46x0,52x1,62 m
 Peso 90 kg.

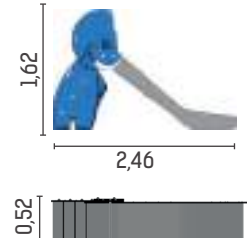
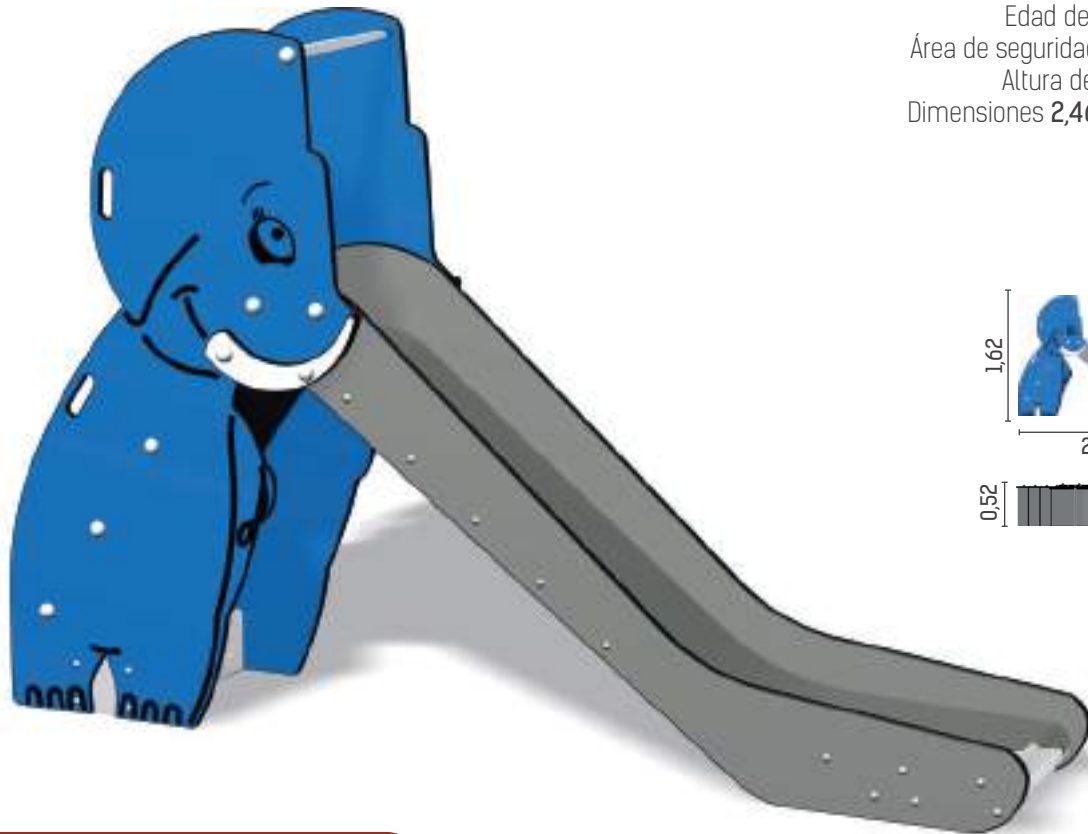

TOBOGANES, materiales predominantes:

Paneles de polietileno alta densidad (HDPE) y rampas de acero inoxidable.

LEÓN Ref. 80193

Edad de uso ≥ 2 años
 Área de seguridad 4,95x3,52 m
 Altura de caída 0,88 m
 Dimensiones 2,45x0,52x1,65 m
 Peso 90 kg

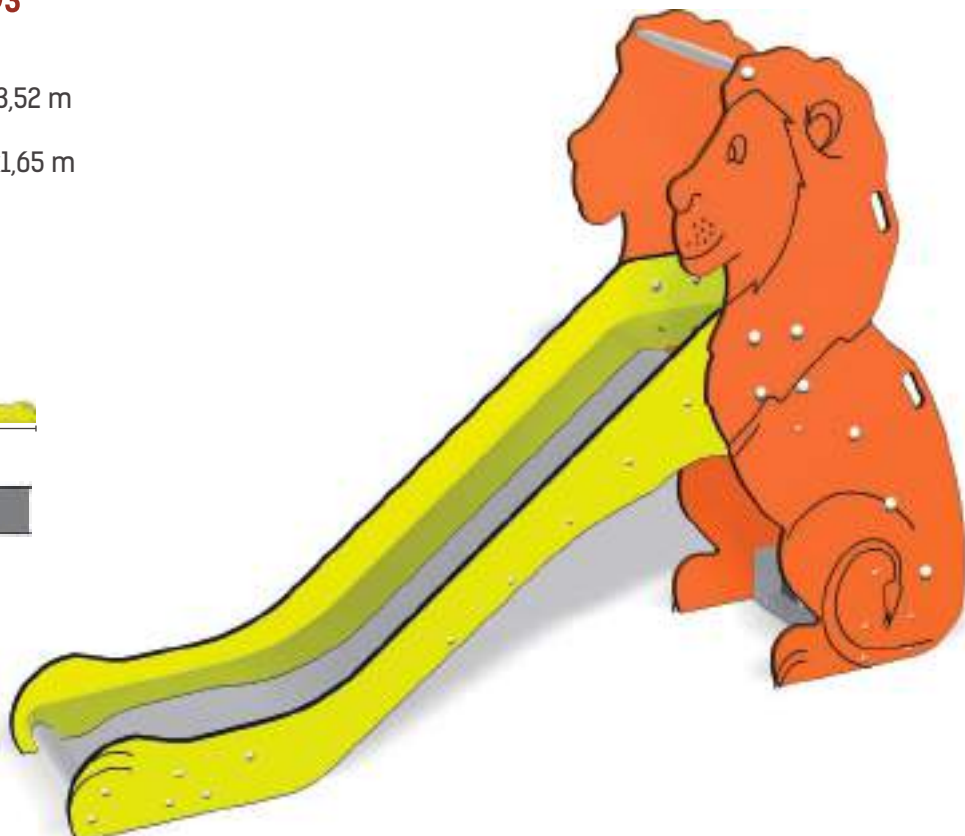
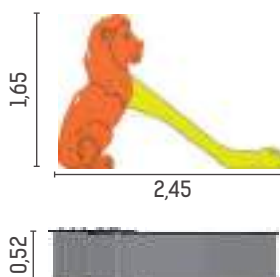

BRAVO MASTER Ref. 80189



Edad de uso \geq 3 años.
 Área de seguridad 5,28x3,52 m
 Altura de caída 1,29 m
 Dimensiones 2,85x0,53x2,03 m
 Peso 52,5 kg.

TOBOGANES BRAVO, materiales predominantes:

Paneles de polietileno alta densidad (HDPE), rampas de acero inoxidable y escalerilla de acero con pintura termolacada

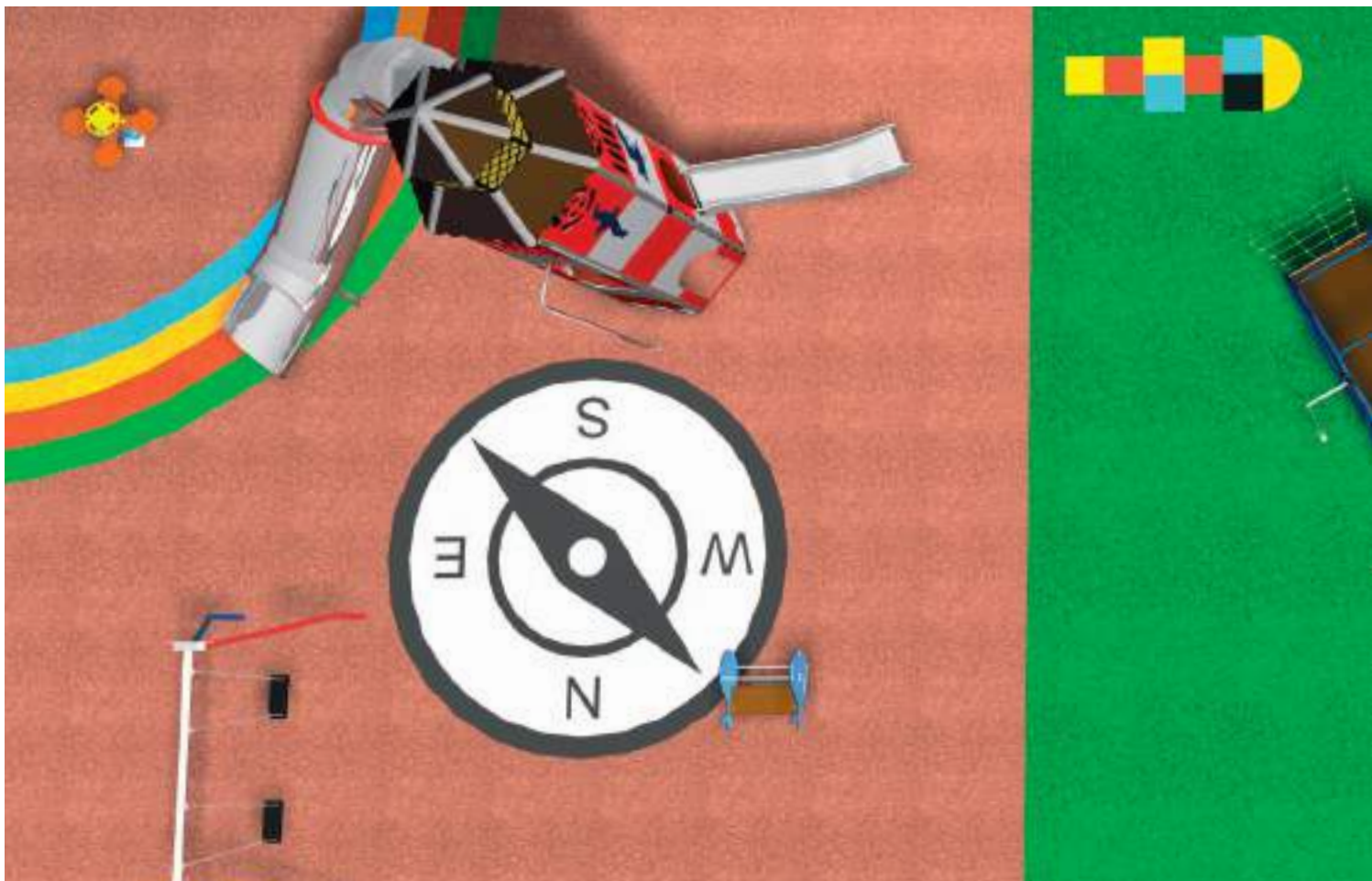
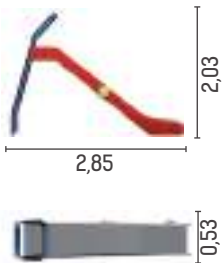

BRAVO JUNIOR Ref. 80190

Edad de uso ≥ 2 años.
 Área de seguridad 4,64x3,52 m
 Altura de caída 0,88 m
 Dimensiones 2,25x0,53x1,62 m
 Peso 40 kg.

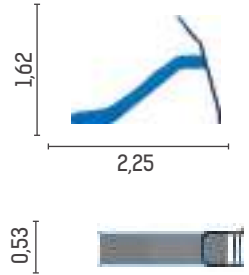

PÓRTICOS / VALLAS



PÓRTICO

POSTES DE MADERA · Ref. 80843

Postes Pino con tratamiento en autoclave, antihumedad y antihongos.
Frontal Tablero de HPL personalizado.
Medidas tablero 2,28x0,63 m



PÓRTICO

POSTES DE METAL · Ref. 80850

Postes Tubo \varnothing 0,001 m.
Frontal Tablero de HPL personalizado.
Medidas tablero 2,28x0,63 m

VALLAS DE ROLLIZO

Madera de pino con tratamiento en autoclave (antihumedad y antihongos). Largueros \varnothing 8 cm Poste \varnothing 12 cm (incluye 1 poste).



SAN ANDRÉS



ALPINA



PARALELA

Ref. 80119 Valla 2m inicio (incluye 2 postes inicio)
Ref. 80120 Valla 2m ampliación (con 1 poste ampl.)

Ref. 80129 Valla 2m inicio (incluye 2 postes inicio)
Ref. 80130 Valla 2m ampliación (con 1 poste ampl.)

Ref. 80144 Valla 2m inicio (incluye 2 postes inicio)
Ref. 80145 Valla 2m ampliación (con 1 poste ampl.)



VALLA MADERA

Postes 90x90 mm, Largueros 80x35 mm, Lamas 120x20 mm.
Ref. 80355 Metro lineal valla madera.
Ref. 80868 Poste con anclaje para valla de madera.



PUERTA DE MADERA Ref. 80844

2 Postes de madera 90x90 mm.
2 Largueros de madera 80x35 mm.
5 Lamas de madera 120x20 mm.



HDPE ECO

Ref. 81413 Metro lineal valla HDPE ECO.
Ref. 81398 Poste con anclaje para valla Eco/Recicla.
Fabricada con lamas de HDPE multicolor de 12 mm.
Ref. 81496 Puerta ECO

NOVEDAD



HDPE/HPL RECICLA

Ref. 81414 Metro lineal valla Recicla.
Ref. 81398 Poste con anclaje para valla Eco/Recicla.
Fabricada con lamas de varios colores y espesores. Estructura de tubo galvanizado. (CONSULTE AHORRO Y DISPONIBILIDAD)
Ref. 81497 Puerta Recicla

VALLAS / PUERTAS

NOVEDAD



VALLA DE SEGURIDAD PARALELA

(Valla quitamiedos) Postes $\varnothing 100$ mm, Largueros $\varnothing 60$ mm.

Ref. 80242 Metro lineal valla seguridad Paralela metálica.

Ref. 80243 Poste inicio valla seguridad Paralela.

Ref. 80244 Poste ampliación valla seguridad Paralela.

Ref. 80245 Poste esquina valla seguridad Paralela.

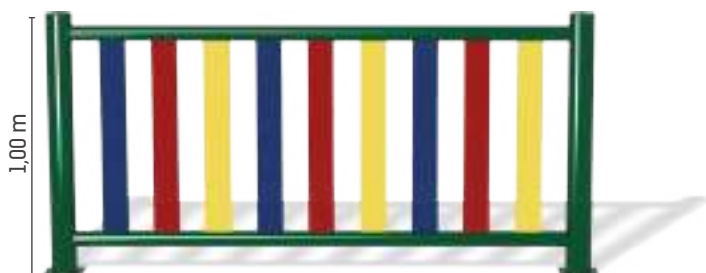

VALLA METÁLICA

Postes $\varnothing 100$ mm, Largueros $\varnothing 60$ mm, Lamas 100x20 mm.

Ref. 80732 Metro lineal valla Metálica desmontable.

Ref. 80865 Poste inicio valla Metálica desmontable.

Ref. 80866 Poste ampliación valla Metálica desmontable.

Ref. 80867 Poste esquina valla Metálica desmontable.



PUERTA LAMAS DE METAL

Ref. 80883

2 postes de tubo $\varnothing 100$ mm.

Marco de tubo $\varnothing 60$ mm.

4 Lamas de tubo de 100x20 mm.



VALLA POLIETILENO

Postes $\varnothing 100$ mm, Largueros 50x30 mm, Lamas de polietileno.

Ref. 80377 Metro lineal valla Polietileno 15 mm.

Ref. 80862 Poste inicio valla Polietileno.

Ref. 80863 Poste ampliación valla Polietileno.

Ref. 80864 Poste esquina valla Polietileno.



PUERTA VALLA POLIETILENO

Ref. 80845

2 postes de tubo $\varnothing 100$ mm.

Marco de tubo 50x30 mm.

4 Lamas de polietileno (15 mm).

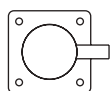

POSTE INICIO

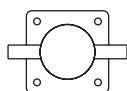

POSTE AMPLIACIÓN

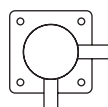

POSTE ESQUINA

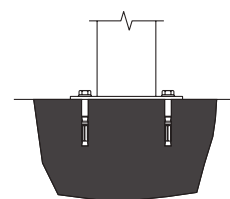

Detalle anclaje con
tacos de expansión

PAVIMENTO DE CAUCHO - LOSA

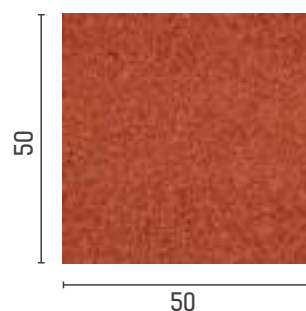

sanpe
ingeniería

Ref. 80254

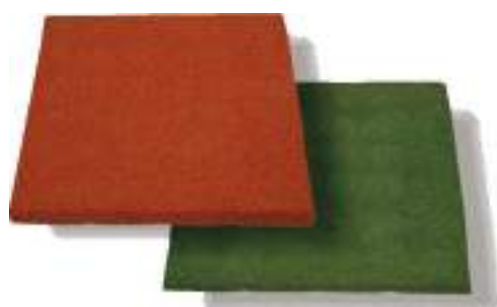

LOSETA DE CAUCHO

50 x 50 x 4 cm
Mod. 80450 (Burdeos)
Mod. 80529 (Verde)

BORDILLO DE CAUCHO

50 x 50 x 4 cm
Mod. 80618 (Burdeos)
Mod. 80619 (Verde)

* Posibilidad de distintos grosores 2-4-6 m. Colores disponibles: Verde y Burdeos.

PAVIMENTO DE CAUCHO CONTINUO



Pavimento in situ, compuesto por una capa base de gránulo de caucho SBR reciclado, acabado con una capa de gránulo de caucho natural de EPDM del color deseado. Aglomerado mediante resinas de poliuretano, logrando una excelente superficie de amortiguación con los dibujos y diseños deseados.

LOSA DE CAUCHO HEXAGONAL

PANHEX

PATENTADA

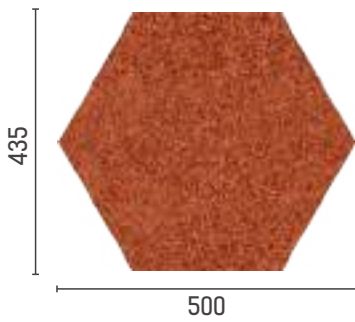

REMATES PERIMETRALES DE CHAFLÁN

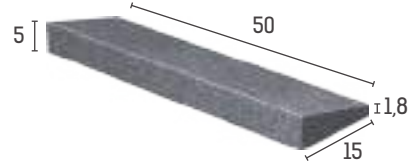

Cod. 81171
Bordillo recto



Cod. 81172
Bordillo esquina

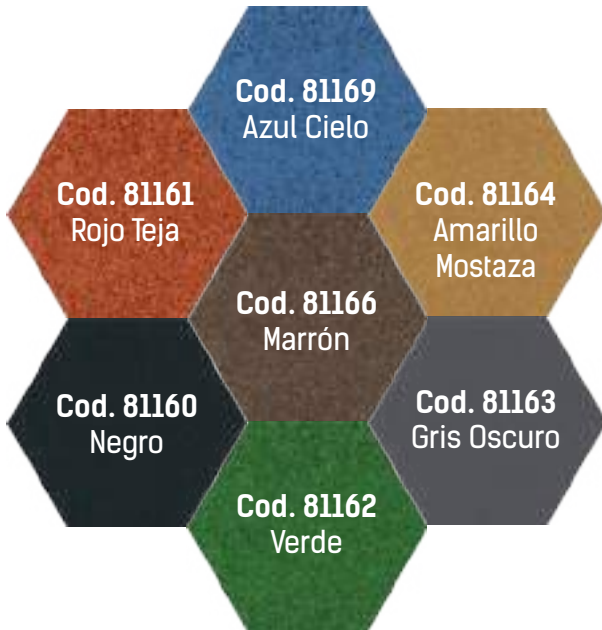

PANHEX es una exclusiva loseta hexagonal, fabricada con caucho reciclado SBR pigmentado, de gránulo fino, con cara lisa y reticulado tipo panel de abeja. El diseño de esta loseta está basado en la estructura de panel de abeja, lo que le proporciona

una resistencia uniforme en toda su superficie, logrando un excelente comportamiento de amortiguación ante los impactos, alcanzando con sus 5 cm de grosor, un **HIC de 1,70m** en ensayos según norma EN-1177 (Patentada).

CÉSPED ARTIFICIAL



El césped artificial Colors Kids cumple todas las normativas vigentes de seguridad en parques infantiles

UNE EN 14041

La novedosa composición de sus fibras hace que la carga electrostática del césped se disipe y no se acumule sobre él.

ASTM G 21:2013

Las fibras de Colors Kids están tratadas con productos anti-bacterias consiguiendo que su césped esté libre de cualquier bacteria.

UNE EN ISO 12616:2003

La base amortiguadora de nuestra gama "colors" cuenta con el doble de drenaje para una mayor afluencia de líquidos y suciedad, doble drenaje, doble limpieza.

UNE EN 1177

Junto a RealPad, conseguimos seguridad adicional frente a posibles caídas, ya que ofrece una base de amortiguación.

UNE EN ISO 11925-2:2001

Los materiales con los que fabricamos Colors Kids, hacen que sea totalmente ignífugo, evitando así que se incendie ante una exposición accidental al fuego



COLOR KIDS



La instalación de nuestro modelo de césped artificial para parques infantiles Colors Kids dotará a cualquier zona de juegos de un aspecto mucho más atractivo y amigable para que los más pequeños desarrollen y experimenten grandes momentos de diversión.

Nuestro modelo de césped artificial Colors Kids es una opción inmejorable para que los más pequeños puedan disfrutar de su tiempo de juego minimizando al máximo los riesgos de accidente.

CALIDAD | TECNOLOGÍA | GARANTÍA

COLORES DIPONIBLES DE CÉSPED ARTIFICIAL



Colors Kids cuenta con 5 tecnologías dirigidas a cumplir todas las normativas para un parque seguro. Gracias a la composición de sus fibras es:

- ❖ 100% Antiestático
- ❖ 100% Antibacterias
- ❖ 100% Ignífugo

Nuestro césped se caracteriza por una alta calidad de sus monofilamentos, costuras y backing. En definitiva, un césped altamente resistente.

Cuenta con una base amortiguadora de diferentes alturas que, junto con nuestro césped artificial, cumplen con todas las normativas de seguridad y hacen más seguras las posibles caídas de los más pequeños.





EN 16630

Aparatos para el ejercicio al aire libre. Los materiales predominantes son: Acero galvanizado con imprimación de pintura de poliéster al horno. Asientos y embellecedores de polietileno y rodamientos y piezas mecánicas de primera calidad. Colores: Verde oscuro (RAL 6005); Verde claro (RAL 6024). Con la garantía de fabricación de EEUU.

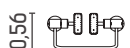
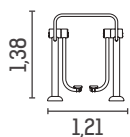

PASEO Ref. 80935

Área de seguridad 4,55x4,21 m

Peso 50 kg

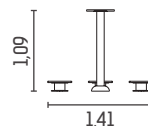

GIRO DE CINTURA Ref. 80936

Área de seguridad \varnothing 4,59 m

Peso 37 kg

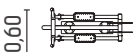
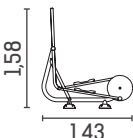

ESQUÍ DE FONDO Ref. 80931

Área de seguridad 3,60x4,43 m

Peso 44 kg

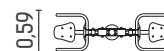
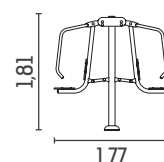

GÉMINIS Ref. 80945

Área de seguridad 5,49x3,59 m

Peso 62 kg

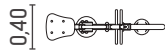
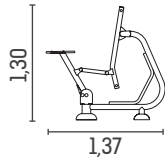

JINETE Ref. 80938

Área de seguridad 3,40x4,38 m
Peso 30 kg

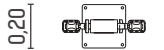
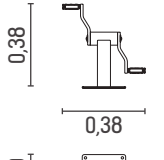

CICLO-PEDAL Ref. 80913

Área de seguridad 3,70x4,08 m
Peso 4 kg

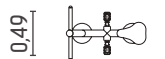
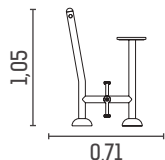

CICLOSTÁTIC Ref. 80902

Área de seguridad 3,49x3,71 m
Peso 13 kg

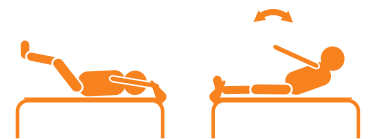
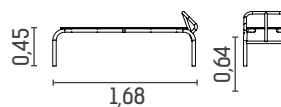

BANCOS ABDOMINALES HDPE Ref. 81281

Área de seguridad 3,52x4,68 m



EN 16630

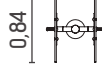
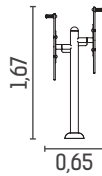
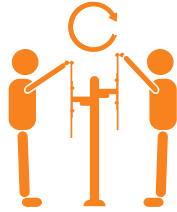

NORIAS Ref. 80933

Área de seguridad 3,84x3,65 m
Peso 45 kg

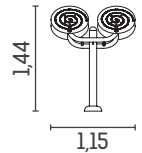
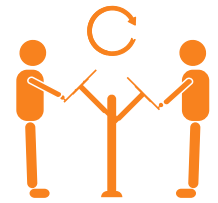

VOLANTES Ref. 80937

Área de seguridad 4,21x4,15 m
Peso 51 kg

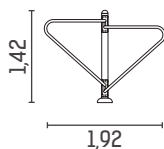
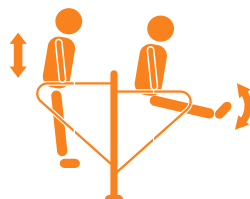

BARRAS PARALELAS Ref. 80977

Área de seguridad 3,55x4,92 m
Peso 28 kg

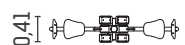
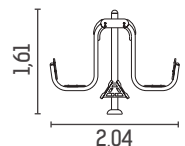
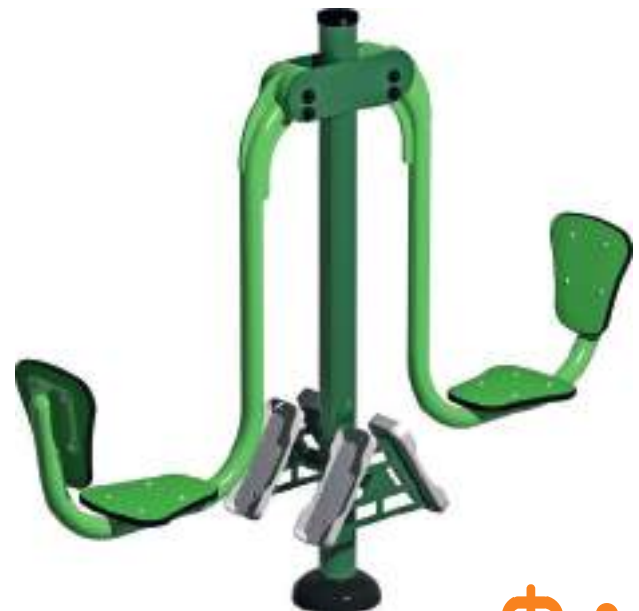

COLUMPIO Ref. 80914

Área de seguridad 3,41x5,61 m
Peso 74 kg.

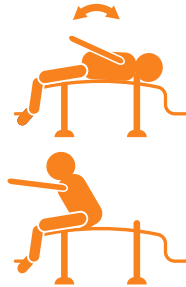
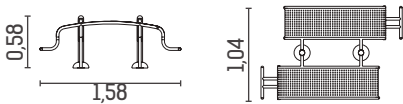

BANCOS ABDOMINALES

Ref. 80944

Área de seguridad 4,04x4,58 m

Peso 41 kg

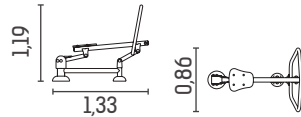

REMO Ref. 80939

Área de seguridad 4,33x3,86 m

Peso 26 kg

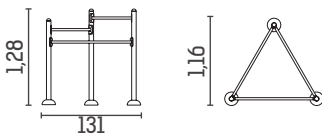

BARRAS ESTIRAMIENTO

Ref. 80272

Área de seguridad 4,16x4,31 m

Peso 32 kg

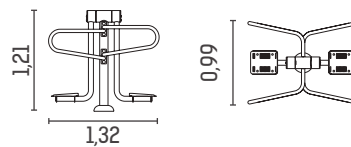

SURF Ref. 80975

Área de seguridad 3,99x4,33 m

Peso 53 kg



CARTEL
Ref. 81167

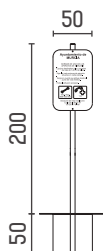

PROTECTORES
(Incluidos)

Cod. 80299 Tubo Ø 60
Cod. 80298 Tubo Ø 100



ANCLAJES

Cod. 80909 Anclaje suelo juego Bios 1 Poste.
Cod. 80289 Anclaje suelo Bios Giro de Cintura.
Cod. 80907 Anclaje suelo Bios Paseo.
Cod. 80905 Anclaje suelo Bios Remo/Jinete.
Cod. 80906 Anclaje suelo Esqui Fondo/Ciclost./B. Abdom.



PLACAS IDENTIFICATIVAS
(Incluidas)



EN 16630

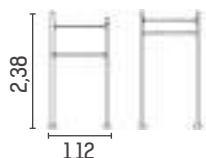
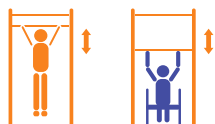

BARRA DOMINADAS Ref. 80908

Área de seguridad 4,20x4,20 m

Dimensiones 1,12x1,12x2,38 m

Peso 58 kg

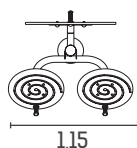
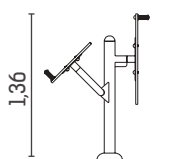

COMBI VOLANTES/NORIA Ref. 81280

Área de seguridad 3,97x4,15 m

Peso 37 kg

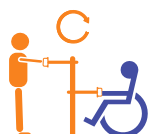
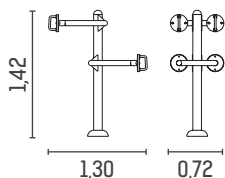
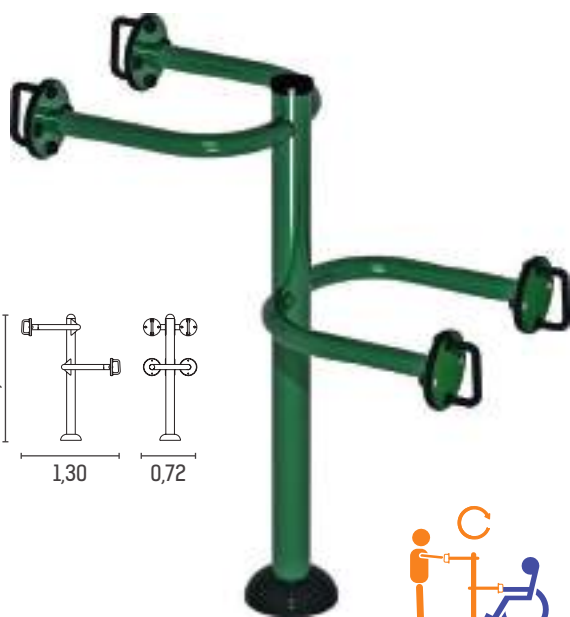

GIRO DE MUÑECAS Ref. 81265

Área de seguridad 3,72x4,30 m

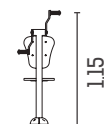

PEDAL DE BRAZOS Ref. 81266

Área de seguridad 3,30x3,86 m





ESCALADA
Ref. 80948



ESPALDERA INCLINADA
Ref. 80951



ESPALDERA
Ref. 80963



PARALELAS
Ref. 80950



VALLAS
Ref. 80958



FLEXIONES
Ref. 80952



LUMBARES
Ref. 80966



BARRA EQUILIBRIO
Ref. 80953



ABDOMINALES
Ref. 80949



PÉRGOLA 3X3 M
Ref. 80276



PÉRGOLA 6X5 M
Ref. 80277

Postes verticales de 14x14 cm Vigas de carga de 16x8 cm Viguetas de 12x6 cm
Materiales: Madera de abeto laminada, antihumedad y antihongos.

CALISTENIA

CALISTENIA



El nivel de exigencia lo pones tú.

Conforme a la norma EN16630

Ref. (hormigón)	Nombre	Dimensiones instalado (frente x fondo x alto*) (m)	Peso (Kg)	Área de seguridad (m)	Altura de caída (m)
81520	BARRA DOMINADAS CLASICA 1500 H2500	1,60x0,10x2,51	46	4,60x3,10	1,42
81521	BARRA DOMINADAS CLASICA 1500 H2000	1,60x0,10x2,01	38	4,60x3,10	0,92
81522	BARRA DOMINADAS CLASICA 1200 H2500	1,30x0,10x2,51	46	4,30x3,10	1,42
81523	BARRA DOMINADAS CLASICA 1200 H2000	1,30x0,10x2,00	38	4,30x3,10	0,92
81524	BARRA DOMINADAS Z 1200 H2500	1,30x0,10x2,51	46	4,30x3,10	1,42
81525	BARRA DOMINADAS Z 1200 H2000	1,30x0,10x2,00	38	4,30x3,10	0,91
81526	PARED SUECA	1,30x0,10x2,51	69	4,30x3,10	1,38
81527	BARRAS PARALELAS H1200 DOBLE	1,80x0,55x1,22	22	4,80x3,55	1,22
81528	BARRAS PARALELAS H1200 TRIPLE	1,80x1,05x1,22	33	4,80x4,05	1,22
81529	PARALELAS SUELO H200 DOBLE	1,80x0,55x0,20	13	4,80x3,55	0,20
81530	PARALELAS SUELO H200 TRIPLE	1,80x1,05x0,20	19	4,80x4,05	0,20
81531	BANCO ABDOMINALES HORIZONTAL	1,66x0,85x0,76	41	4,66x3,85	0,65
81532	BANCO ABDOMINALES INCLINADO	1,66x0,85x1,21	49	4,66x3,85	1,08
81533	MONKEY BAR HORIZONTAL	2,10x1,30x2,51	113	5,10x4,30	1,42
81534	MONKEY BAR INCLINADA	2,10x1,30x2,51	101	5,10x4,30	1,30
81535	MONKEY BAR SERPIENTE	2,10x0,68x2,51	58	5,10x3,68	1,42
81536	BARRA FLEXIONES TRIPLE FRANCESA	3,70x0,10x1,61	49	6,70x3,10	1,32

* Para la instalación en arenero, sumar 0,5 m a la altura de cada modelo.

MATERIALES:

Acero galvanizado por inmersión en caliente, postes de tubo cuadrado 90x90 mm y barras de tubo redondo de $\varnothing 35$, $\varnothing 42,4$ y $\varnothing 50$ mm, paneles y tapetas de polietileno de alta densidad (HDPE), y tornillería de acero galvanizado.

**NORMA
EN-16630**



PARALELAS SUELO H200

Modelo Hormigón - Arena
DOBLE Ref. 81529 - Ref. 81547
TRIPLE Ref. 81530 - Ref. 81548



PARALELAS H1200

Modelo Hormigón - Arena
DOBLE Ref. 81527 - Ref. 81545
TRIPLE Ref. 81528 - Ref. 81546

CALISTENIA



TRIPLE FRANCESA

Ref. 81536 - Hormigón / Ref. 81554 - Arena



MONKEY BAR HORIZONTAL

Ref. 81533 - Hormigón / Ref. 81551 - Arena



MONKEY BAR INCLINADO

Ref. 81534 - Hormigón / Ref. 81552 - Arena



MONKEY BAR SERPIENTE

Ref. 81535 - Hormigón / Ref. 81553 - Arena



PARED SUECA

Ref. 81526 - Hormigón / Ref. 81544 - Arena



BARRA DOMINADAS Z

Modelo Hormigón - Arena
1200 H2500 Ref. 81524 - Ref. 81542
1200 H2000 Ref. 81525 - Ref. 81543



BARRA DOMINADAS CLÁSICA

Modelo Hormigón - Arena
1500 H2500 Ref. 81520 - Ref. 81538
1500 H2000 Ref. 81521 - Ref. 81539
1200 H2500 Ref. 81522 - Ref. 81540
1200 H2000 Ref. 81523 - Ref. 81541



BARRA VERTICAL

Ref. 81555



BANCO ABDOMINALES INCLINADO

Ref. 81532 - Hormigón / Ref. 81550 - Arena



BANCO ABDOMINALES HORIZONTAL

Ref. 81531 - Hormigón / Ref. 81549 - Arena

* Los elementos de calistenia para arenero van fraguados con hormigón.

CALISTENIA

NORMA
EN-16630

* Color verde RAL 6032



CIRCUITO CALISTENIA ALFA

Ref. 81501 - Hormigón /Ref. 81507 - Arena

Área de seguridad 8,79x8,30 m
Altura de caída 1,42 m
Dimensiones 5,30x5,50x2,51 m
Peso 485 Kg

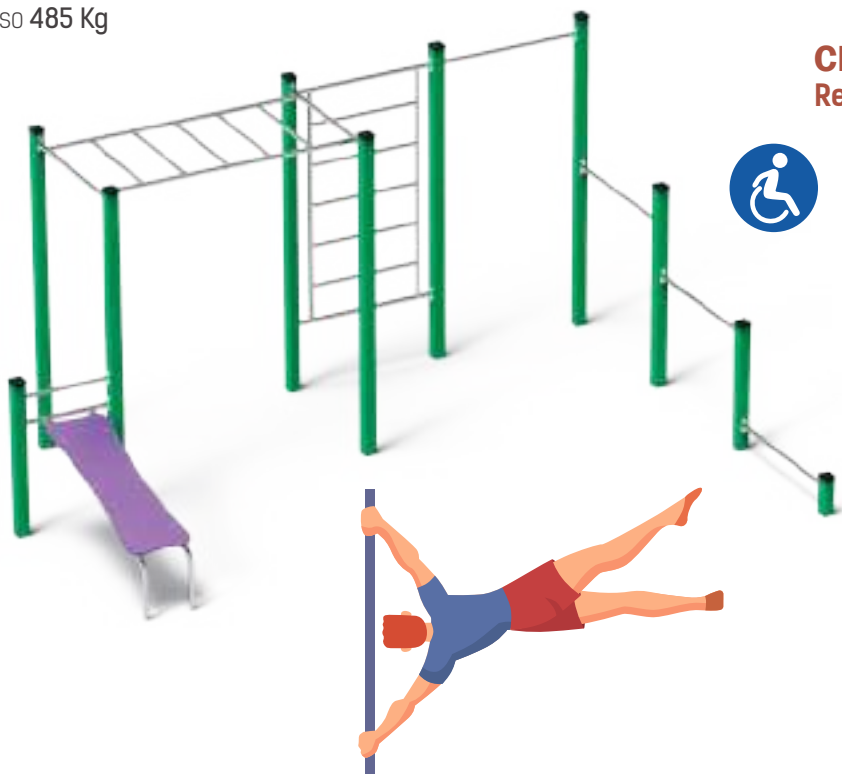

CIRCUITO CALISTENIA GAMMA

Ref. 81503 - Hormigón /Ref. 81509 - Arena

Área de seguridad 8,25x5,86 m
Altura de caída 1,42 m
Dimensiones 5,86x8,25x2,51 m
Peso 256 Kg

CIRCUITO CALISTENIA ÉPSILON

Ref. 81505 - Hormigón /Ref. 81511 - Arena

Área de seguridad 8,25x5,39 m
Altura de caída 1,42 m
Dimensiones 2,39x5,25x2,51 m
Peso 193 Kg

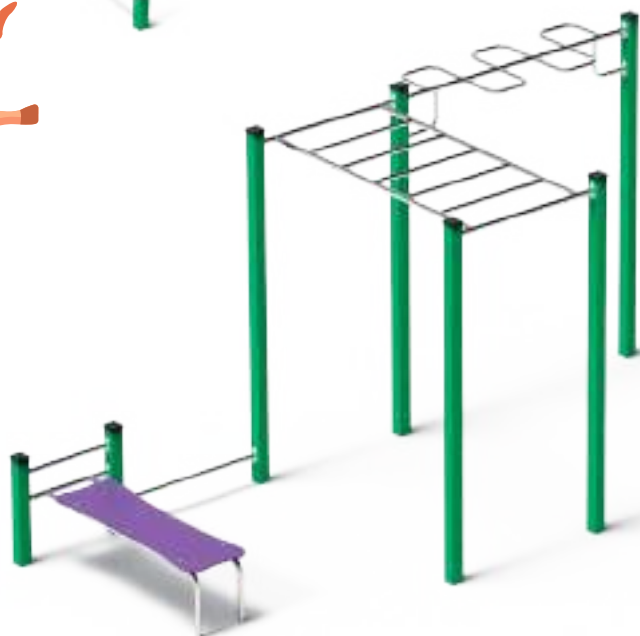

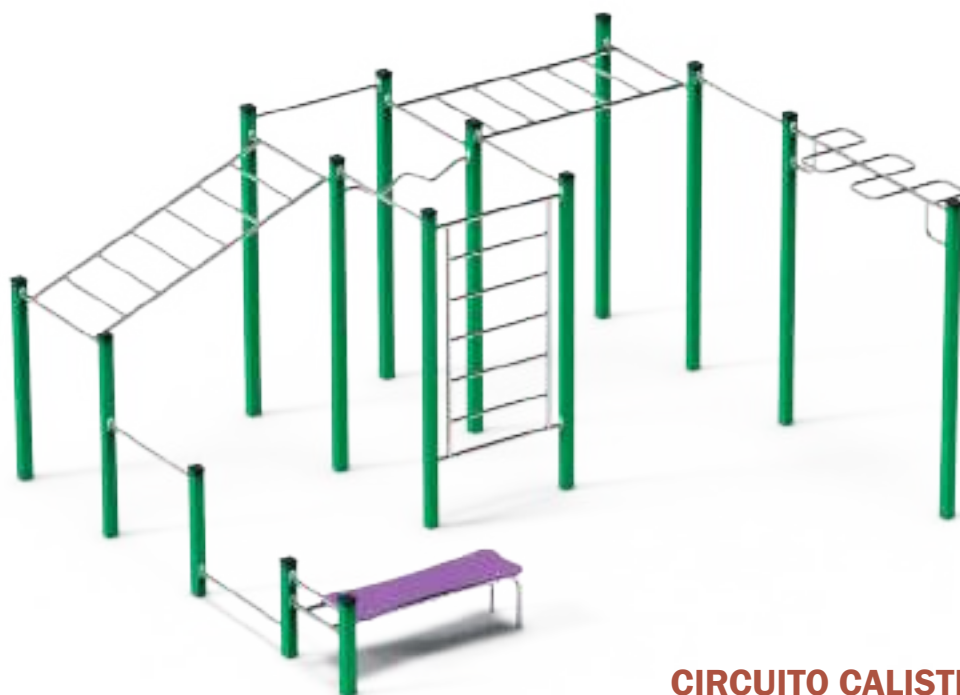

CIRCUITO CALISTENIA BETA
 Ref. 81502 - Hormigón /Ref. 81508 - Arena

Área de seguridad 8,30x7,45 m
 Altura de caída 1,42 m
 Dimensiones 5,30x4,45x2,51 m
 Peso 407 Kg

CIRCUITO CALISTENIA DELTA
 Ref. 81504 - Hormigón /Ref. 81510 - Arena

Área de seguridad 8,25x6,59 m
 Altura de caída 1,42 m
 Dimensiones 8,59x8,25x2,51 m
 Peso 266 Kg

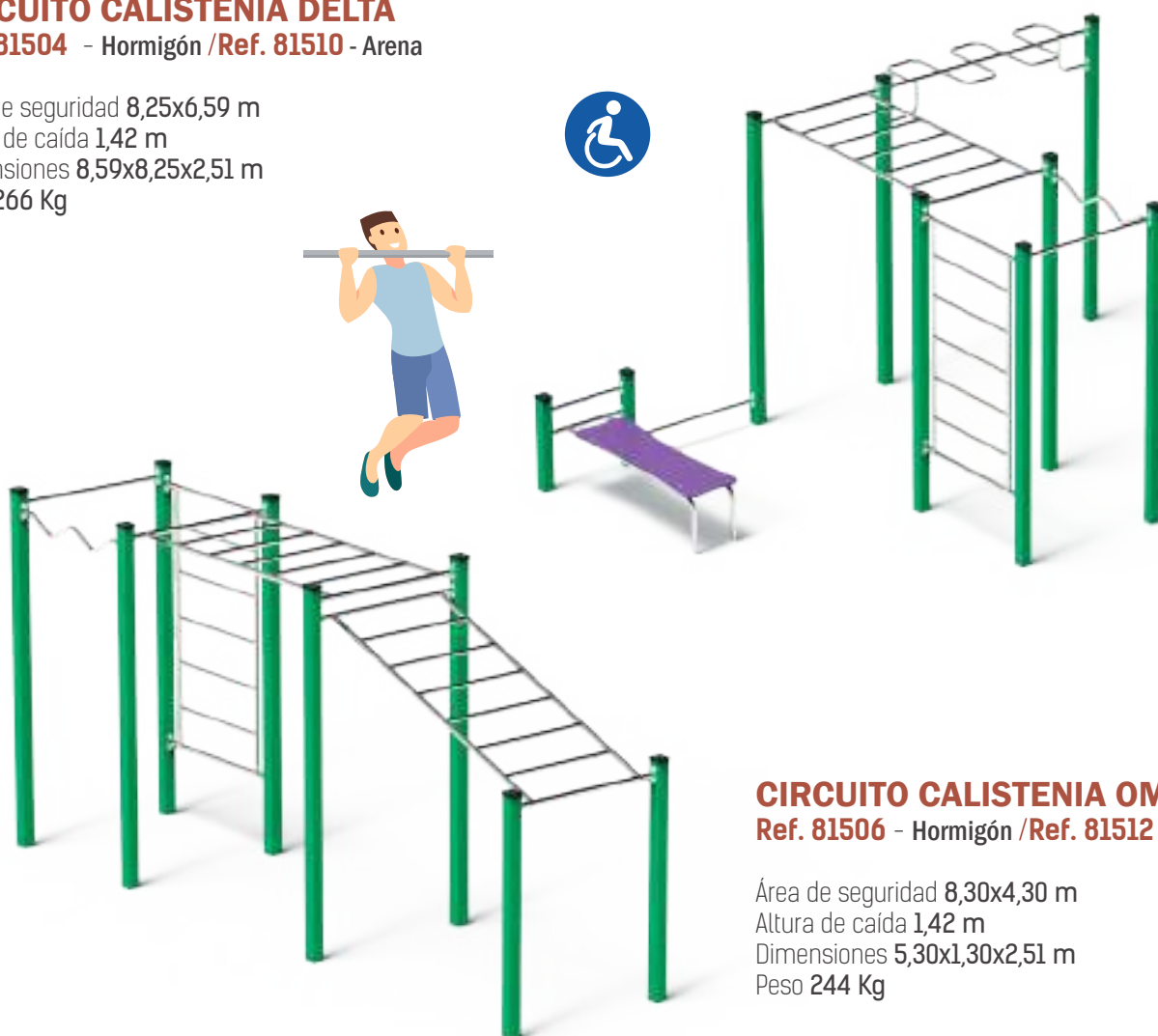

CIRCUITO CALISTENIA OMEGA
 Ref. 81506 - Hormigón /Ref. 81512 - Arena

Área de seguridad 8,30x4,30 m
 Altura de caída 1,42 m
 Dimensiones 5,30x1,30x2,51 m
 Peso 244 Kg

PISTAS MULTIDEPORTE HDPE

NOVEDAD

Materiales predominantes: perfiles de acero, con recubrimiento de galvanizado en caliente.



Ref. 81606 - Frontal HDPE

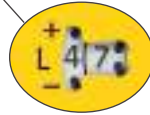

Detalle del marcador

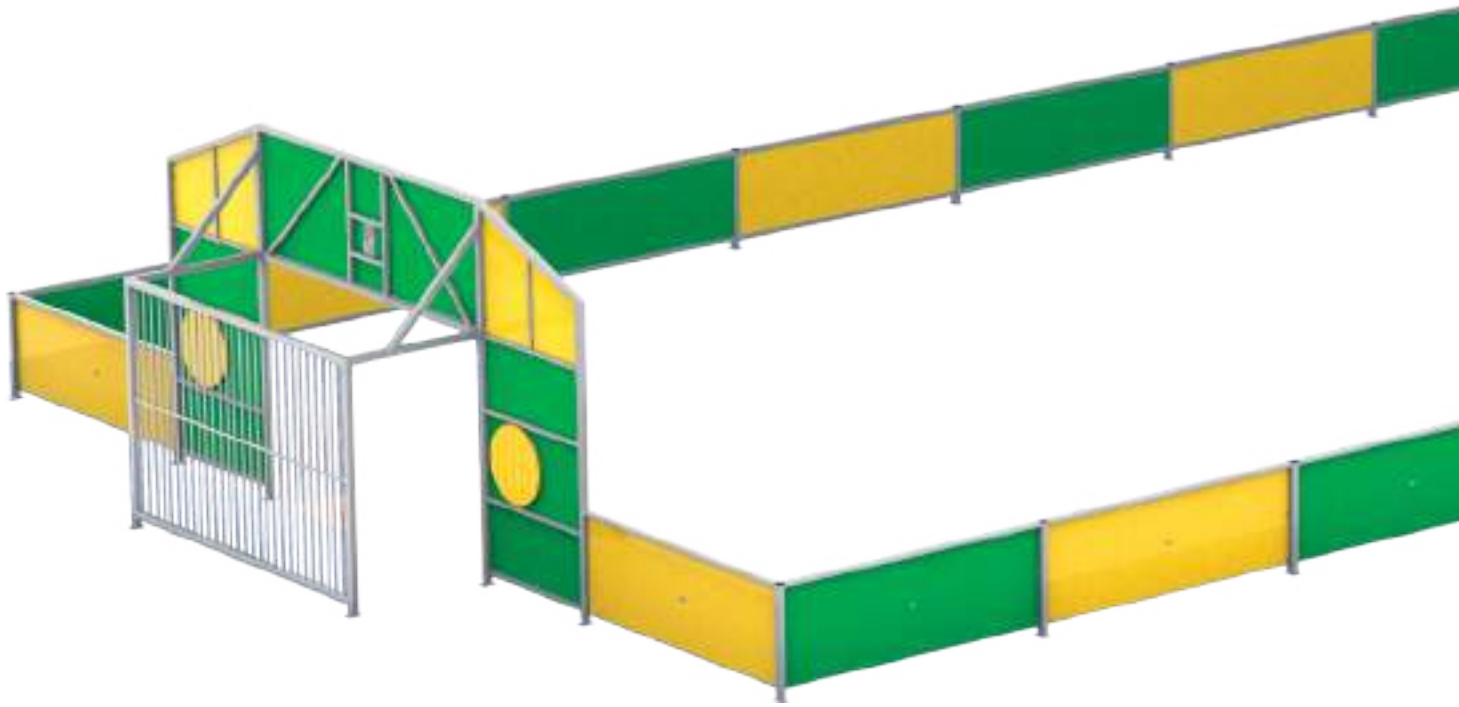



MODELOS DE PISTA ESTÁNDAR

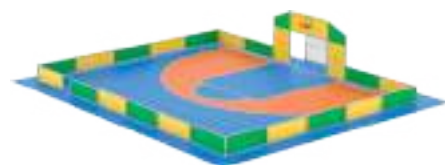

Ref. 81605 16x12,5 m. con 1 frontal

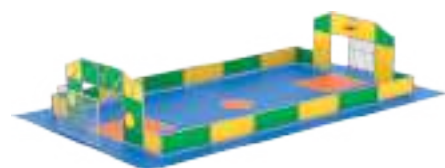

Ref. 81601 8,2x15 m



Ref. 81602 11x20 m

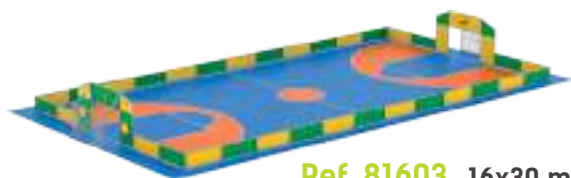

Ref. 81603 16x30 m

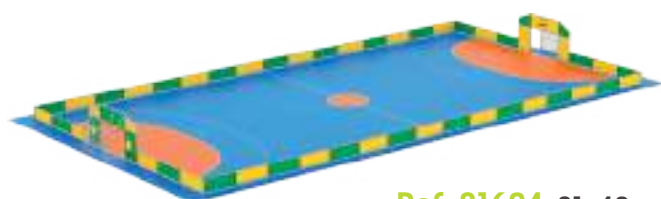

Ref. 81604 21x40 m

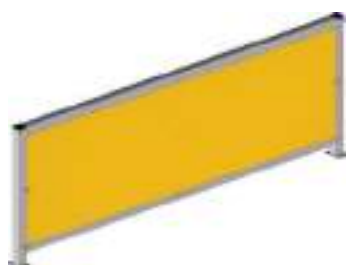

VALLAS PARA PISTA

Ref. 81607 - Valla panel HDPE 2,5 m (2 pilares esquina)

Ref. 81608 - Valla panel HDPE 2,5 m (2 pilares inicio)

Ref. 81609 - Valla panel HDPE 2,5 m (1 pilar ampliación)

Ref. 81610 - Valla panel HDPE 2,5 m (sin pilares)

Ref. 81611 - Valla panel HDPE 1,25 m (sin pilares)

*Para más detalles consulte las fichas técnicas en nuestra web www.krealiagestion.com

PISTAS METÁLICAS



Materiales predominantes: perfiles de acero galvanizado y todo recubierto con pintura de poliéster al horno.

RENOVADO

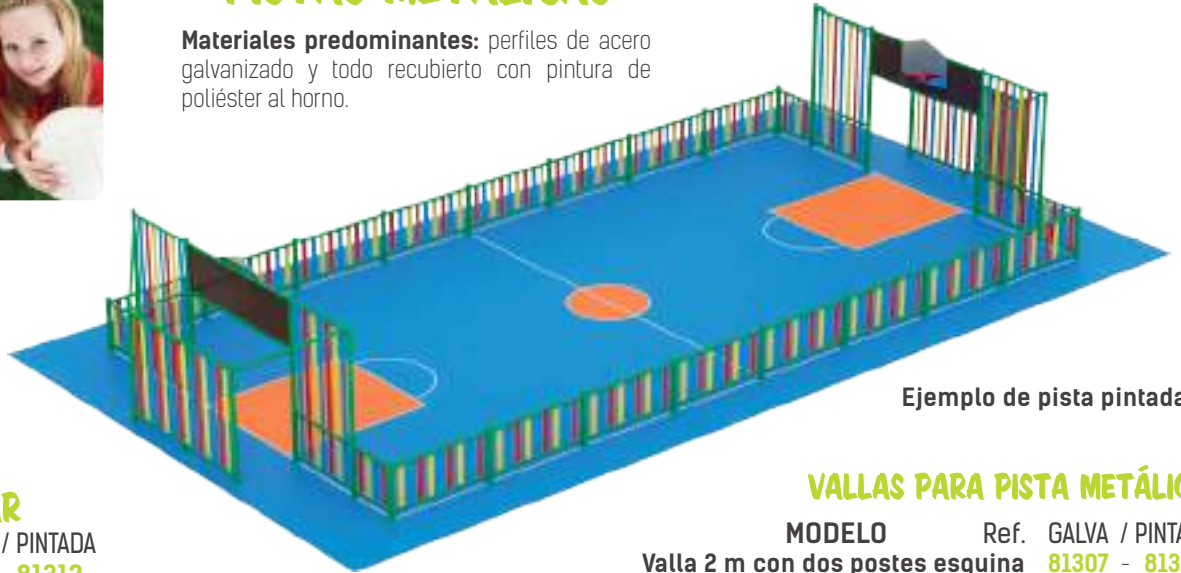

Ejemplo de pista pintada

PISTAS ESTÁNDAR

MODELO	Ref. GALVA / PINTADA
8x16 m	81302 - 81312
10x20 m	81303 - 81313
14x28 m	81304 - 81314
18x36 m	81305 - 81315
14x12 m	81306 - 81316 (Con 1 frontal)

VALLAS PARA PISTA METÁLICA

MODELO	Ref. GALVA / PINTADA
Valla 2 m con dos postes esquina	81307 - 81317
Valla 2 m con 1 poste ampliación	81308 - 81318
Valla 2 m sin postes	81309 - 81319
Valla 1 m sin postes	81310 - 81320
Valla 1 m con dos postes inicio	81321 - 81322

PISTA VERSIÓN GALVA

Materiales predominantes: perfiles de acero galvanizado y pintura de poliéster al horno (excepto lamas).



Frontal con portería+canasta
Ref. 81301 - Ref. 81311 Galvanizada - Pintada

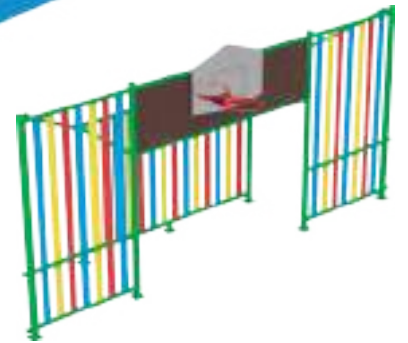

TRIBUNA 12 PLAZAS (3 PISOS) DESMONTABLE
Ref. 80218 - 80224 Inicio - Ampliación

TRIBUNA 8 PLAZAS (2 PISOS) DESMONTABLE
Ref. 80286 - 80287 Inicio - Ampliación

ASIENTO GRADA MODELO A2
Ref. 80579 - 80584 Azul - Rojo



Materiales Acero galvanizado.
Formado por soportes, bancada, reposapiés y respaldo en el tercer piso.



PORTERIA FUTBOL SALA ANTIVANDALICA Ref. 81485

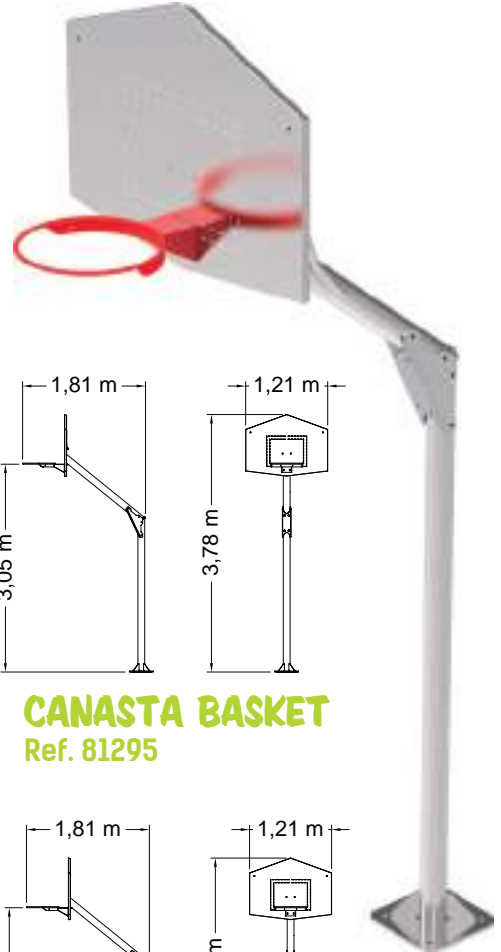
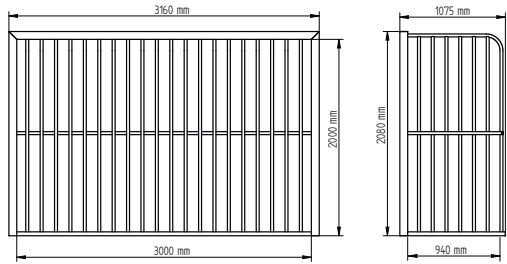

CANASTA BASKET Ref. 81295



ARO SUELTO Ref. 80662

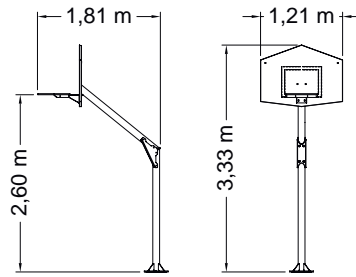

CANASTA MINIBASKET Ref. 80926



PERCHERO PARED

Ref. 80363 (1,50 m)
Ref. 80364 (2 m)



BANCO VESTUARIO

Ref. 80302 (1,50 m)
Ref. 80303 (2 m)

Dimensiones 2 o 1,50x0,40x0,45 m
Materiales Estructura de acero lacada
Asiento de listones de madera de pino

TAQUILLA VESTUARIOS PRO

Ref. 80141

Dimensiones 0,40x0,50x2,15 m
Materiales Chapa de acero
Pintura de poliéster termolacada
Cerradura Zamak con dos llaves
Ventilación trasera y en suelo
Porta etiquetas
Balda con perchero y divisoria



BANCOS

BANCO ROMÁNTICO

REF. 80313

Dimensiones 2x0,67x0,70 m
Patas de fundición, asiento y respaldo madera tropical.



BANCO ALPINO

REF. 80306

Dimensiones 1,8x0,5x0,93 m
Asiento y respaldo madera de eucalipto.



BANCO MADRID Ref. 80839

Dimensiones 2x0,63x0,73 m
Patas Acero termolacado gris oxirón.
Asiento y respaldo madera de pino lacada.





SILLÓN ABRIL Ref. 80856
Dimensiones 0,70x0,61x0,84 m

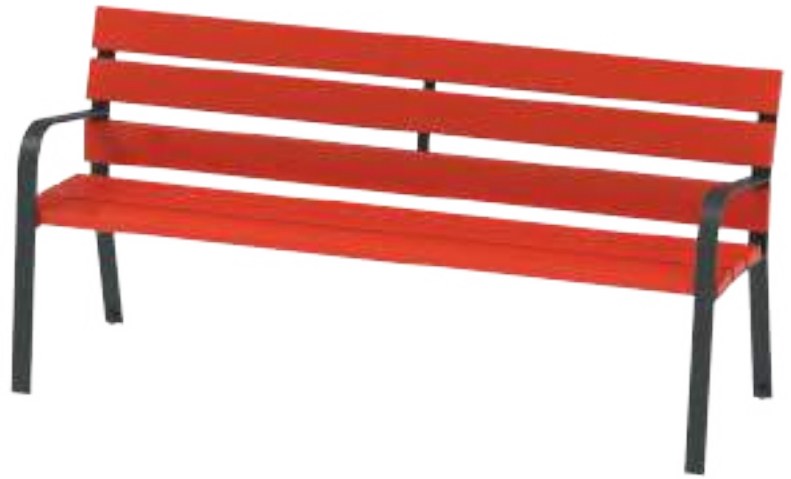

BANCO ABRIL Ref. 80473
Dimensiones 1,80x0,61x0,84 cm



BANCO ABRIL Ref. 80295
(S/APOYA-BRAZOS)







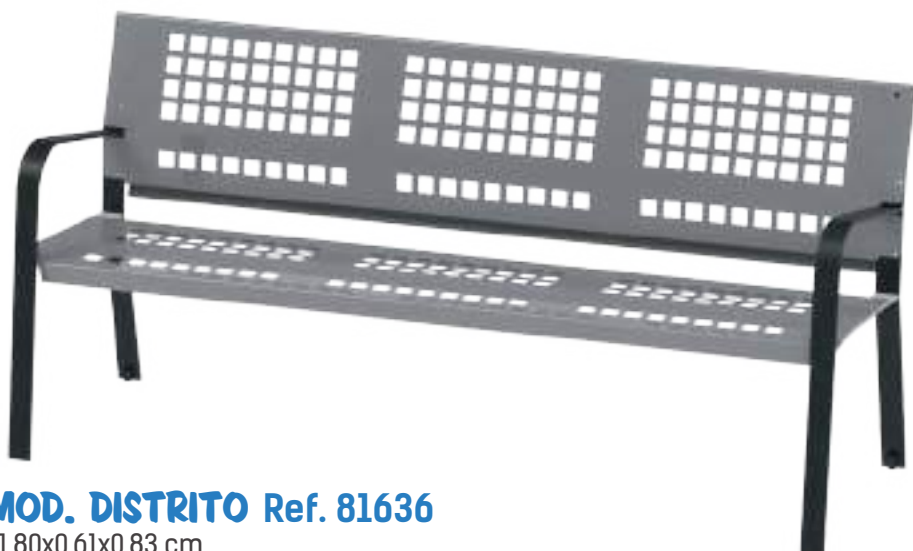

SILLA ABRIL Ref. 80294
(S/APOYA-BRAZOS)

LÍNEA BANCOS ABRIL, materiales predominantes: asiento y respaldo madera tropical lacada, patas de acero y recubiertas con pintura termolacada gris oxirón.



BANCO MOD. DISTRITO Ref. 81636
Dimensiones 1,80x0,61x0,83 cm

Fabricado en chapa galvanizada de 2,5 mm, patas y apoyabrazos en pletina, acabados con imprimación y pintura poliéster termolacada.

-  Gris 7040
-  Amarillo 1003
-  Verde 6002
-  Rojo 3020
-  Azul 5015
-  Lila 4005

BANCOS



BANCO ATENEO Ref. 80808

Dimensiones 2x0,50x0,44 m

Acabado Hormigón prefabricado armado

Peso 465 Kg

Colocación Apoyado o anclado



BANCO ROMA Ref. 80810

Dimensiones 2x0,50x0,40 m

Acabado Hormigón prefabricado armado

Peso 860 Kg

Colocación Apoyado o anclado



BANCO ZORBA Ref. 80809

Dimensiones 202x0,60x0,45 m

Acabado Hormigón prefabricado armado

Peso 530 Kg

Colocación Apoyado o anclado



BANCO ESPARTA Ref. 80833

Dimensiones 2x0,58x0,80 cm

Acabado Hormigón prefabricado armado. Con respaldo.

Peso 900 Kg

Colocación Apoyado o anclado



BANCO ISQUIÁTICO Ref. 80228

Dimensiones 1,49x0,30x0,92 m

Acabado Tubo galvanizado y HDPE

Colocación Anclado con pernos de expansión



PROTECTOR PARA FAROLAS Y ÁRBOLES Ref. 81168

Dimensiones 0,65x0,65x0,81 m

Acabado Tubo galvanizado acabado con pintura al horno

Colocación Se sujeta empotrado al suelo

BANCO MODELCONFORT

Ref. 80300

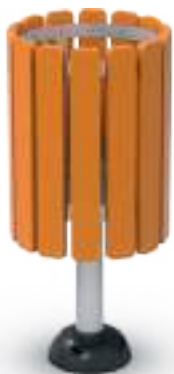
Dimensiones 2x0,57x0,82 m
Acabado pintura negro forja oxidón.**NOVEDAD****35L****PAPELERA NATUR HDPE 35L**

Ref. 81345

Estructura de acero galvanizado y lamas de polietileno y base con embellecedor.
Dimensiones 0,33x0,83**BANCO NATUR HDPE** Ref. 81346

Dimensiones 2x0,44x0,47

**BANCO FUNDICIÓN** Ref. 80307Dimensiones 2x0,52x0,80
Acabado pintura negra

LÍNEA ÉLITE

BANCO ÉLITE SIN RESPALDO CON APOYABRAZOS Ref. 81435

Dimensiones 1,75x0,40x0,64 m

NOVEDAD



BANCO ÉLITE SIN RESPALDO Ref. 81434

Dimensiones 1,75x0,40x0,45 m



BANCO ÉLITE DOBLE CON APOYABRAZOS Ref. 81437

Dimensiones 1,75x0,81x0,64 m



COLORES ESTÁNDAR SERIE ÉLITE



Amarillo 1003



Verde 6002



Azul 5015



Gris 7040









Lila 4005



Rojo 3020





-  Gris 7040
-  Amarillo 1003
-  Verde 6002
-  Rojo 3020
-  Azul 5015
-  Lila 4005

BANCO ÉLITE Ref. 80341

Dimensiones 1,80x0,62x0,78 m



BANCO ÉLITE 4 APOYABRAZOS
Ref. 81260

Dimensiones 1,80x0,62x0,78 m



SILLA ÉLITE Ref. 81248

Dimensiones 0,59x0,62x0,78 m



SILLÓN ÉLITE Ref. 81249

Dimensiones 0,59x0,62x0,78 m

LÍNEA ÉLITE, materiales predominantes: Asiento y respaldo en chapa galvanizada de 2,5 mm, patas y apoyabrazos de pletina. Acabados con imprimación de pintura poliéster termolacada.

LÍNEA ESPACIAL

BANCO ESPACIAL SIN RESPALDO CON APOYABRAZOS Ref. 81462

Dimensiones 1,75x0,40x0,64 m

NOVEDAD



BANCO ESPACIAL SIN RESPALDO Ref. 81463

Dimensiones 1,75x0,40x0,45 m

BANCO ESPACIAL DOBLE CON APOYABRAZOS Ref. 81464

Dimensiones 1,75x0,81x0,64 m



COLORES ESTÁNDAR SERIE ESPACIAL



Amarillo 1003



Verde 6002



Azul 5015



Gris 7040



Lila 4005



Rojo 3020





BANCO ESPACIAL Ref. 81457

Dimensiones 1,80x0,62x0,78 m



BANCO ESPACIAL 4 APOYABRAZOS
Ref. 81458

Dimensiones 1,80x0,62x0,78 m



SILLA ESPACIAL Ref. 81460

Dimensiones 0,59x0,62x0,78 m



SILLÓN ESPACIAL Ref. 81461

Dimensiones 0,59x0,62x0,78 m

LÍNEA ÉLITE, materiales predominantes: Asiento y respaldo en chapa galvanizada de 2,5 mm, patas y apoyabrazos de pletina. Acabados con imprimación de pintura poliéster termolacada.

MESA DE JUEGOS ESTÁNDAR

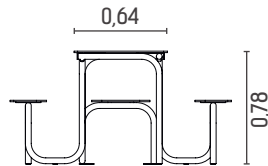
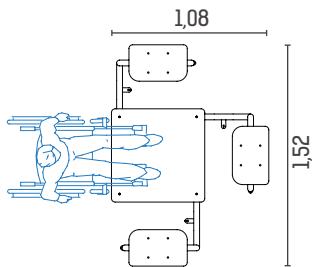

PARCHÍS

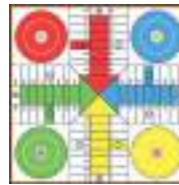

Ref. 80220

Ref. 81225

AJEDREZ

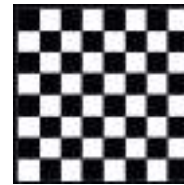

Ref. 80221

Ref. 81226

OCA



Ref. 80223

Ref. 81227

MESA INCLUSIVA



HPL de máxima resistencia UV (EN438-6)



MESA PIC-NIC Ref. 80722

Madera de pino con tratamiento en autoclave, antihumedad y antihongos.

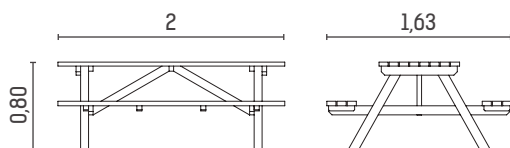









PAPELERA GRAN VÍA DELUXE
Ref. 80752

Dimensiones 0,48x0,48x0,84 m / Capacidad 95L
Tapa, zócalo y esquinas de ACERO INOX
Cuerpo de chapa galva. con pintura al horno
Cubeta interior extraíble y tapa con cierre



-  Gris oxidado
-  Gris 7040
-  Amarillo 1003
-  Verde 6002
-  Rojo 3020
-  Azul 5015
-  Lila 4005

PAPELERA PORTALÓ Ref. 80544

Dimensiones 0,45x0,80 m / Capacidad 55L
Chapa galva/imprimación/pintura al horno
Cubeta interior extraíble en chapa galva
Tapa con cierre de seguridad
Colores personalizados



PAPELERA ZEUS Ref. 80411

Dimensiones 0,48x0,46x0,81 m / Capacidad 60L
Cuerpo en acero con imprim. y pintura
Chapa efecto madera.
Cubeta interior extraíble en chapa galva.
Tapa con cierre de seguridad



PAPELERA MEDITERRÁNEO
Ref. 80483

Esqueleto en acero con pintura gris oxidado
Envoltura de madera tropical
Cubeta interior extraíble de chapa galva
Dimensiones 0,46x0,71 m
Capacidad 40 L



40L

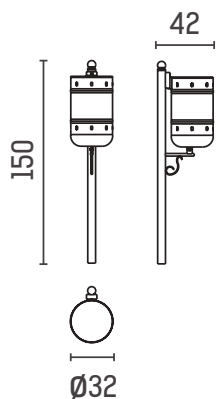

PAPELERA HIDALGO Ref. 80546

Dimensiones 0,42x1,50 m
 Cubeta chapa acero de 1,2 mm
 Pintura negro forja oxirón.
 Capacidad 40 L



60L

PAPELERA BRUSELAS INOX. Ref. 80213

Dimensiones \varnothing 0,35x0,90 m
 Materiales Acero inoxidable
 Capacidad 60 L
 Tipo Abatible sin cierre



40L

PAPELERA HIDALGO A PARED Ref. 80271

Dimensiones 0,42x0,76 m
 Cubeta chapa acero de 1,2 mm
 Pintura negro forja oxirón.
 Capacidad 40 L



65L

PAPELERA INTEGRAL Ref. 80175

Dimensiones \varnothing 0,37x0,77 m
 Materiales Chapa 1,5 mm
 Pintura Negro forja oxirón
 Capacidad 65 L / Cubeta fija

NOVEDAD



60L



FABRICADO EN ESPAÑA

PAPELERA BARCELONA EU 60L

Ref. 80481

Dimensiones 0,48x0,84 m

Materiales Chapa galvanizada con imprimación y pintura oxirón

Tipo Abatible con tope de seguridad antivoltteo

60L



FABRICADO EN ESPAÑA

PAPELERA BARCELONA EU 60L C/TAPA

Ref. 81623

Dimensiones 0,48x0,96 m

Materiales Chapa Galvanizada con imprimación y pintura oxirón

Tipo Abatible con tope de seguridad antivoltteo y tapa antilluvia



CENICERO UNIVERSAL PARA PAPELERAS

Ref. 80910

Dimensiones 0,80x0,11x0,26 m

45L

45L



PAPELERA ULISES FIJA Ref. 81465

Dimensiones Ø 0,37x0,85 m

Materiales Chapa 1,5 mm, pintura oxirón

Capacidad 45 L

Tipo fija

PAPELERA ULISES ABATIBLE Ref. 80412

Dimensiones Ø 0,37x0,85 m

Materiales Chapa 1,5 mm, pintura oxirón

Capacidad 45 L

Tipo abatible con tope y cierre de seguridad

PAPELERAS



DISPENSADOR BOLSAS
Ref. 80100 verde
Ref. 81451 galvanizado



ROLLO 500 BOLSAS
Ref. 80987

PAPELERA MODELO PIPICAN CON DISPENSADOR DE BOLSAS

Ref. 80227 verde
Ref. 81450 galvanizado
Fabricada en chapa galvanizada y pintura termolacada.
Dimensiones 0,30x0,30x1,22 m

NOVEDAD

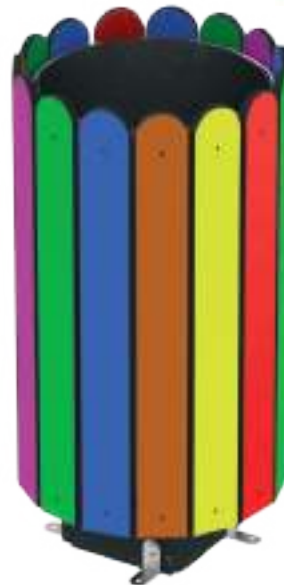

90L

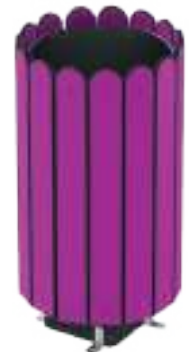

PAPELERA RECICLA 90L

Ref. 81635
Fabricada en HDPE
Dimensiones 0,40x0,81 m
Colores de lamas variados según disponibilidad







PAPELERAS SELECTIVAS PARA SEPARACIÓN DE RESIDUOS

Cuidamos el medio ambiente



45L X 3



-  Gris oxirón
-  Azul 5015
-  Verde 6002
-  Amarillo 1003



PAPELERA SELECTIVA TRIPLE LINEAL Ref. 80288

Chapa de 1,5 mm de espesor
Capacidad 45L (x3)
Dimensiones 0,37x1,36x0,85 m

PAPELERA INDIVIDUAL CON SOPORTE DE PARED Ref. 81466



60L

NOVEDAD



30L X 3



PAPELERA MODELO BARCELONA EU 60L C/TAPA

Ref. 81623 Color selectivo en la tapa

Fabricada en chapa galvanizada y pintura termolacada.
Dimensiones 0,44x0,96 m

PAPELERA MOD. SELECTI 90L

Ref. 81625

Fabricada en chapa galvanizada y pintura termolacada.
Capacidad 3 x 30 L = 90 L
Dimensiones 0,46x 0,98 m



45L X 3

PAPELERA TRÉBOL Ref. 80269

Chapa de 1,5 mm
Capacidad 45L (x3)
Dimensiones 0,71x0,76x0,93 m



25L

PAPELERA MOD. TRIANGLE GALVANIZADA Ref. 81438

PINTADA Ref. 81439

Dimensiones 0,31x0,36x0,86 m
Capacidad 25L





SERIE ACUATERRA

La serie **ACUATERRA** se compone de duchas de uno y tres rociadores, lava pies y fuente de agua potable para consumo humano, diseñadas para instalar en exteriores. En su fabricación se han empleado materiales de primera calidad, como acero inox AISI 316 brillante, tapa superior y zócalo de HPDE y accesorios de primeras marcas, con lo que se garantiza su durabilidad en ambientes exigentes como costa y playas. En todos los casos se usan pulsadores temporizados, lo que permite un consumo responsable de agua. La fuente ACUATERRA además, lleva incorporado un filtro de carbono para mejorar la calidad del agua a consumir.

Su diseño, con esquinas redondeadas, tapa de registro integrada y la combinación del INOX con el HPDE, marcan una diferenciación de calidad y estética incomparable.



PASARELA MADERA PLAYA Ref. 81292

Dimensiones 2 x1,20 m.

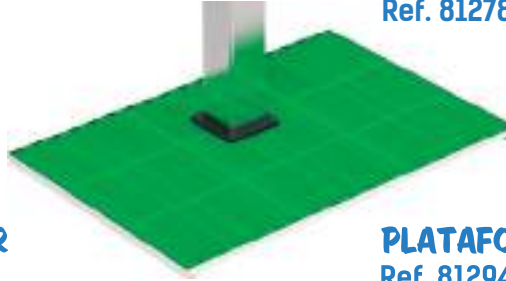
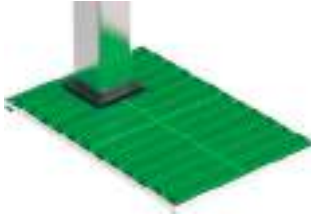

PLATAFORMA DUCHA 1 ROCIADOR Ref. 81293

Dimensiones 1,23x0,83x0,50 m.

DUCHAS ACUATERRA

Ref. 81279 - Ducha inox 3 salidas (42x52x218 cm)

Ref. 81278 - Ducha inox 1 salida (32x42x218 cm)

PLATAFORMA DUCHA 3 ROCIADORES Ref. 81294

Dimensiones 1,83x1,23x0,50 m.

FUENTE ACUATERRA

CON ARQUETA

Ref. 81277

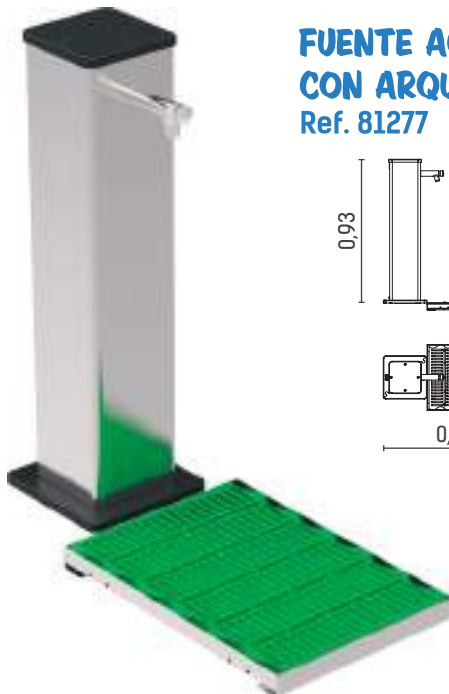
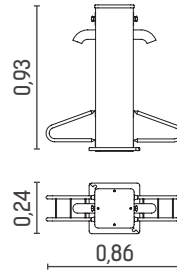
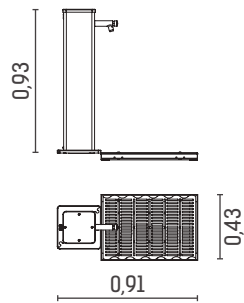

LAVAPIÉS ACUATERRA 2 ROCIADORES

Ref. 81276

(ARQUETAS opcionales Ref. 81291 ud.)



FUENTE INOX INCLUSIVA MODELO CASCADA

Fuente para consumo humano, accesible a personas de movilidad reducida. Incorporando un plato de acero inoxidable se adapta para mascotas.

Dispone de filtro de carbono activo y llave de paso para regulación de caudal y altura de chorro.

Preparada para conexión a red pública de agua potable.

Presión máxima de uso 4 bar.



Ref. 81270 - Fuente inox Inclusiva.

Ref. 81275 - Fuente inox con arqueta y plato.

Ref. 81291 - Arqueta inox y rejilla de plástico (sin plato).

Ref. 81284 - Plato inox.

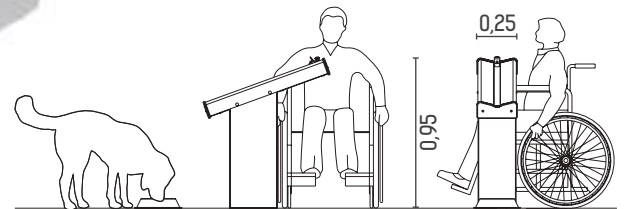

Materiales: Acero inoxidable AISI-316 y polietileno de alta densidad (HDPE).

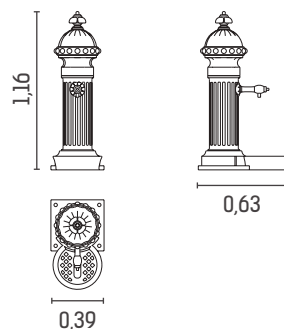
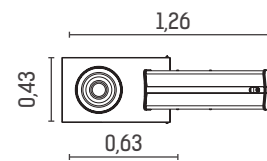

TURIA Ref. 80461

Dimensiones 0,39x0,63x1,16 m

Materiales Fundición hierro. Imprimación + Oxirón.

Grifo Pulsador temporizado con regulación de caudal.

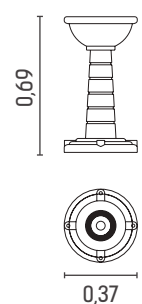

INFANTIL Ref. 80462

Dimensiones 30,3x0,69 m

Materiales Fundición hierro. Imprimación + Oxirón.

Grifo Vertical chorro continuo.

JARDINERAS

JARDINERA RECTANGULAR

Ref. 80896

Jardinera fabricada en chapa galvanizada recubierta de imprimación y pintura oxirón al horno.

Dimensiones 0,42x0,82x0,44 m

Capacidad 104 Litros



JARDINERA CIRCULAR

Jardinera fabricada en chapa galvanizada recubierta de imprimación y pintura oxirón al horno.

MEDIANA - Ref. 80892 GRANDE - Ref. 80893

Dimensiones Ø 0,82x0,60 m Ø 1,12x0,85 m

Capacidad 243 Litros 698 Litros

JARDINERA CUADRADA

Ref. 80898

Jardinera fabricada en chapa galvanizada recubierta de imprimación y pintura oxirón al horno.

Dimensiones 0,82x0,82x0,60 m

Capacidad 322 Litros



JARDINERA HORMIGÓN

Ref. 80890

Dimensiones 1,0x0,40x0,60 m

Material Hormigón hidrofugado armado

Acabado Liso

Peso 180 Kg



JARDINERA HORMIGÓN REDONDA

Ref. 80840

Dimensiones Ø 0,80x0,45 m

Material Hormigón hidrofugado armado

Acabado Liso

Peso 220 Kg

JARDINERA HORMIGÓN CUADRADA

Ref. 80841

Dimensiones 0,86x0,86x0,55 m

Material Hormigón hidrofugado armado

Acabado Liso

Peso 330 Kg



JARDINERA RECTANGULAR MADERA

Ref. 80275

Fabricada con madera de pino tratada riesgo IV y fondo protector al agua.

Dimensiones 1,0x0,40x0,39 m



JARDINERA CUADRADA MADERA

Ref. 80274

Fabricada con madera de pino tratada riesgo IV y fondo protector al agua.

Dimensiones 0,70x0,70x0,55 m



OPCIÓN A

APARCABICIS HORQUILLA

Ref. 80969

Dimensiones 0,75x0,97 m
Tubo de acero galvanizado ø50x2 mm



Composición para 6 bicicletas



APARCABICIS DOBLE

Ref. 80884

Dimensiones 0,47x0,47x0,85 m
Tubo de acero pintado



OPCIÓN B

CEPO TUBO PARKING ABATIBLE

Ref. 80918 (Galvanizado)

Ref. 80917 (Galvanizado y pintado)

Dimensiones 0,74x0,64x0,53 m
Materiales Tubo Galvanizado de 50x2 mm



HORQUILLA PINTADA

Ref. 80350

Dimensiones 1,26x0,39 m
Materiales Tubo ø50x2 mm decapado

HORQUILLA INOXIDABLE

Ref. 80371

Dimensiones 0,93x0,43 m
Materiales Acero AISI 304L pulido ø48,3x2 mm

HORQUILLA GALVANIZADA

Ref. 80354

Dimensiones 0,93x0,39 m
Materiales Tubo ø50x2 mm galvanizado



PILONA DE CAUCHO
Ref. 80398

Dimensiones ø 0,14x0,69 m
Caucho vulcanizado.
Recuperable de un golpe.



PARKING ABATIBLE
Ref. 80590

Dimensiones 0,22x0,19x0,84 m
Acero/imprimación/esmalte
Base galva. con cierre llave.



PLATINUM
Ref. 81296

Dimensiones 0,09x0,10x1 m
Aluminio



BRUSELAS Ref. 80494

Dimensiones ø 0,10x1 m
Acero/Pintura oxirón/Inox.

BASE EXTRAÍBLE
Ref. 80497



BRUSELAS PLÁST.
Ref. 81274

Dimensiones ø 0,10x1 m
Poliuretano con argolla reflectante

AGILITY

MESA

Ref. 81174

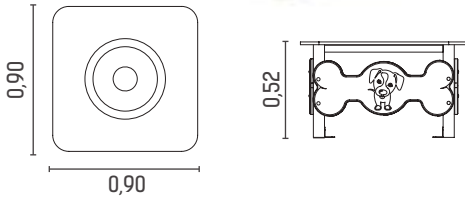

BALANCÍN

Ref. 81173

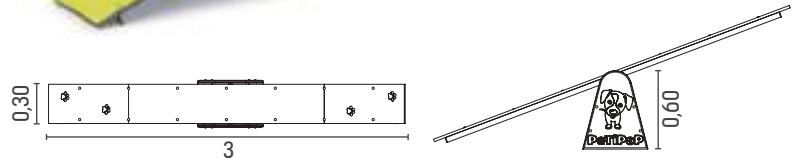

TUNEL

Ref. 81182

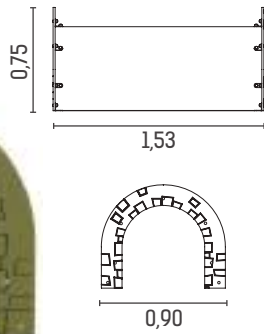

SLALOM

Ref. 81181

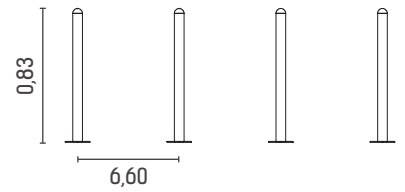

PASARELA

Ref. 81176

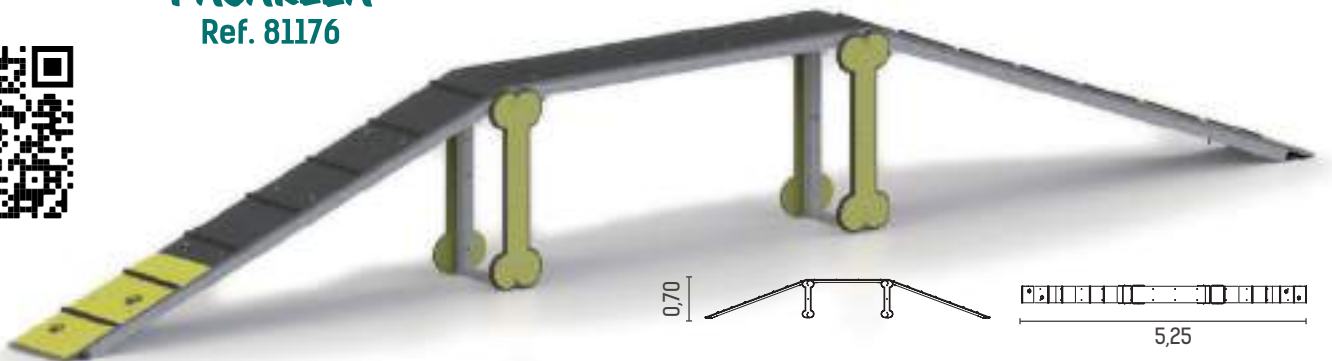

SALTO DE VALLA

Ref. 81180

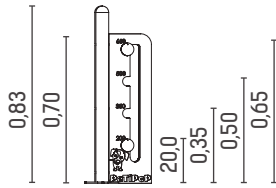

SALTO DE MURO

Ref. 81179

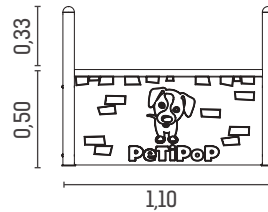

PÓRTICO

Ref. 81178

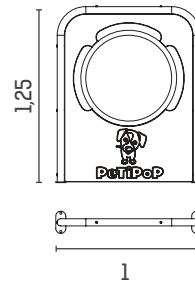
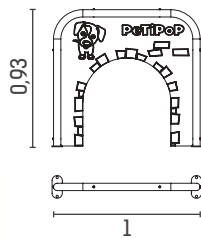

SALTO DE ARO Ref. 81177



SALTO DE LONGITUD

Ref. 81183



Dimensiones 0,90x0,63x0,33 m

EMPALIZADA

Ref. 81267



Dimensiones 2,54x0,60x0,90 m



NOVEDAD

PAPELERA MODELO PIPICAN CON DISPENSADOR DE BOLSAS

Ref. 80227 verde
Ref. 81450 galvanizado
Dimensiones 0,30x0,30x1,22 m



DISPENSADOR BOLSAS

Ref. 81451 galvanizado
Ref. 80100 verde



ROLLO 500 BOLSAS

Ref. 80987



CATÁLOGO
2024



Krealia®

Pol. Ind. Boadilla - Nave 9,
C/Cobalto 45200
ILLESCAS - TOLEDO
Apdo. de correos 104
E-mail: info@krealiagestion.com
Teléfono / Fax: 925 51 14 62

www.krealiagestion.com